

User Manual

**11n/a & 11n/g/b Concurrent Smart Model
WAPS-APG600H**

**11n/a, 11n/g/b Single-Band Smart Model
WAPS-AG300H**



Contents

Chapter 1 - Product Overview	6
Package Contents.....	6
Hardware Overview	7
Front Panel LEDs	7
Back Panel	9
Chapter 2 - Placing Your AirStation.....	10
Antenna Placement.....	10
Installation.....	10
Connecting to PoE Equipment.....	10
Connecting the AC Adapter	11
Mounting the AirStation on a Ceiling or Wall	12
Mounting the Security Case	14
Removing the AirStation	16
Initial Setup	17
Setting the AirStation's IP Address.....	17
Settings.....	19
Wireless & Encryption.....	21
Changing the Password.....	23
Chapter 3 - Configuration	25
Settings	25
Home	25

LAN Settings	26
LAN-side IP Address.....	26
LAN Port.....	27
VLAN	28
Network	29
Proxy ARP	29
Bridge	30
Wireless Settings	32
AOSS.....	32
WPS	34
Basic	35
Advanced.....	37
Security.....	39
Clients	42
WDS.....	43
RADIUS.....	45
MAC Filtering.....	47
WMM.....	48
Wireless Monitor	50
EZ Analyzer.....	50
Administration	51
Username and Password	51
Date and Time	53
Transfer Logs to Syslog Server.....	54
Admin Tools	54
Save/Restore Settings	55
Restart	56
Initialize	56

Update Firmware	57
LED Settings	58
Diagnostic.....	59
System Information	59
Packet Information	61
CPU Monitor	62
I'm Here.....	62
Ping Test.....	63
Traceroute Test	63
USB.....	64
Log	65

Chapter 4 - Connect to a Wireless Network66

Automatic Secure Setup (AOSS/WPS).....	66
Windows 8.1, Windows 8, Windows 7, or Windows Vista (Client Manager V)	67
Windows XP (Client Manager 3).....	68
OS X (AOSS Assistant)	69
Manual Setup	70
Windows 8.1/Windows 8 (WLAN AutoConfig)	70
Windows 7 (WLAN AutoConfig)	71
Windows Vista (WLAN AutoConfig).....	72
Windows XP (Wireless Zero Configuration)	74
OS X (Wi-Fi)	75

Chapter 5 - Checking Wireless Signal Quality76

Windows 8.1, Windows 8, Windows 7, and Windows Vista	76
--	----

OS X.....78

Chapter 6 - Default Configuration Settings.....79

Appendix A - Specifications.....84

Appendix B - TCP/IP Settings86

Windows 8.1/Windows 8.....86

Windows 7.....87

Windows Vista88

Windows XP89

OS X90

Appendix C - Restoring the Default Configuration.....91

Appendix D - Regulatory Compliance Information92

Appendix E - Environmental Information.....98

Chapter 1 - Product Overview

Package Contents

The following items are included in your AirStation package. If any of the items are missing, please contact your vendor.

- Wireless LAN access point 1
- Antennas (with protective caps) 2
- AC adapter 1
- Power cable 1 or 2
- Bracket 1
- Ceiling-mounting screws (large) 4
- Wall-mounting screws (medium) 4
- Wall-mounting anchor (for medium-size screws) 4
- Screws (small, 5 mm *) 2
- Screws (small, 4 mm *) 2
- Spacers (ring-shaped metal part) 2
- Ejector (L-shaped part) 1
- Serial number stickers one sheet with 2 stickers
- Quick setup guide 1
- Warranty statement 1

*  — The “length” here refers to the length of the section shown in the figure.

Hardware Overview

Front Panel LEDs

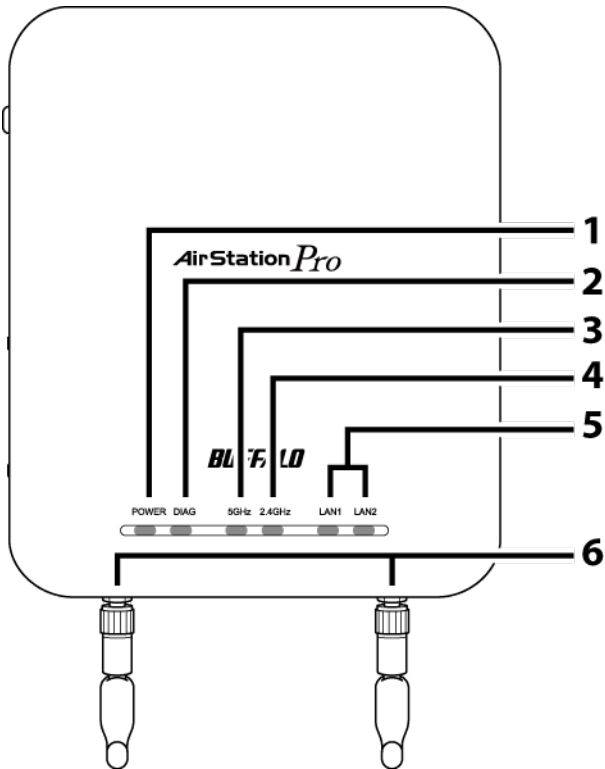

- 1** Power LED
On:
Power is on.
Off:
Power is off.

Note: You can permanently turn off the power LED in Settings.

- 2** Diag LED (Red)
This indicates the status of the unit depending on the number of blinks per cycle.

Note: When the unit is first turned on or restarted, the diag LED will blink for almost a minute during boot. This is normal.

Off:

Normal.

Glow red at startup (about 2 to 3 minutes):

RAM error.

Blinks red twice at startup or immediately after settings are saved:

Flash ROM error.

3 blinks **:

Wired Ethernet LAN error.

4 blinks **:

Wireless LAN error.

5 blinks:

USB error.

9 blinks **:

System error.

Continuously blinking *:

Updating firmware, saving settings, or initializing settings.

* Do not unplug the AC adapter while the diag LED is blinking continuously.

** Turn off AirStation first, wait for a few seconds, then turn it back on.

3 5 GHz LED (Blue)

On:

5 GHz wireless is enabled.

Randomly blinking:

5 GHz wireless is transmitting.

2 blinks:

AirStation is waiting for an AOSS or WPS security key.

Continuously blinking:

AOSS/WPS error; failed to exchange security keys.

Note: You can permanently turn off this LED in Settings.

4 2.4 GHz LED (Green)

On:

2.4 GHz wireless is enabled.

Randomly blinking:

2.4 GHz wireless is transmitting.

2 blinks:

AirStation is waiting for an AOSS or WPS security key.

Continuously blinking:

AOSS/WPS error; failed to exchange security keys.

Note: You can permanently turn off this LED in Settings.

5 LAN LED (Green)

On:

An Ethernet device is connected.

Blinking:

An Ethernet device is communicating.

6 Antenna Connector

Screw on the included antennas here.

Note: The supplied antenna supports both the 2.4 GHz and 5 GHz bands.

Back Panel

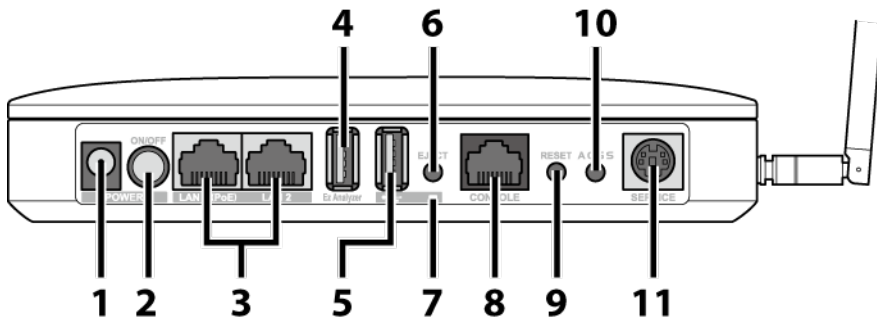

- 1** Power Connector
Connect the power adapter here.
- 2** Power Button
This button turns the power on and off .
- 3** LAN Ports
With Auto-MDIX, you can use straight or crossover Ethernet cables. LAN port 1 supports PoE.
- 4** EZ Analyzer Port
This port is reserved for the upcoming EZ Analyzer function. It is disabled for this firmware release.
- 5** USB Port
Connect a USB device here to upgrade firmware or save logs.
- 6** USB Eject Button
Before unplugging a USB device, hold down the USB eject button for 3 seconds. The USB LED will begin to blink. Then you can unplug the USB device safely.
- 7** USB LED (Green)
On:
USB device is being used.
Randomly blinking:
USB device can be removed.
- 8** RJ-45 Serial Console Port for Settings
This port is reserved for additional functionality in the future. It is disabled for this firmware release.
- 9** Reset Button
To reset all settings, hold down this button until the diag LED comes on (about 3 seconds). Power must be on.
- 10** AOSS/WPS button
To start AOSS (or WPS), hold down this button until the wireless LED blinks twice (about 1 second).
- 11** Maintenance port
For factory use only.

Chapter 2 - Placing Your AirStation

Antenna Placement

Remove the antenna caps and attach the antennas. Don't touch the conductive parts of the antenna connectors because they can be damaged easily.

Note: These antennas support both 2.4 GHz and 5 GHz.

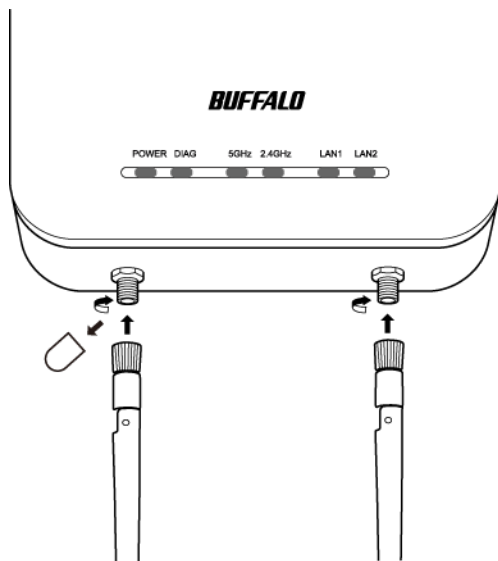

Installation

Connecting to PoE Equipment

The AirStation is compatible with PoE equipment (sold separately). If PoE (Power over Ethernet) is available on the network, you may not need to use the AC power supply. Instead, connect LAN port 1 to an Ethernet connection with PoE as shown below.

Notes:

- LAN port 2 does not support PoE. Don't connect PoE equipment to LAN port 2.
- You may supply power to the AirStation with either PoE or the AC adapter. Do not connect both at once!

- 1 Use an Ethernet cable to connect LAN port 1 of the AirStation to a PoE switch or other device that supports PoE.

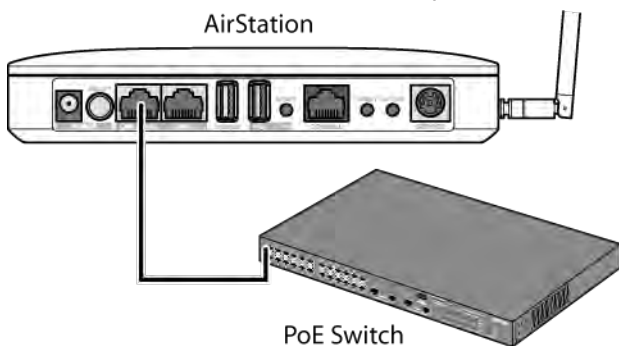

Notes:

- Be sure that the cable connecting the AirStation and power sourcing equipment is an enhanced Category 5 or higher 4-pair cable.
- Connect ITE to PoE networks without routing to the outside plant.

- 2 Power on the AirStation.

- 3 Make sure that the power LED is on.
If the power LED does not turn on after several minutes, make sure that the LAN cable is connected correctly, the AirStation is turned on, and the power source is turned on.

Connecting the AC Adapter

If PoE is not available, connect the AC adapter to the AirStation.

- 1 Use the supplied AC adapter to connect the equipment to a UPS, power strip, or outlet.

- 2 Turn on the AirStation.

- 3 Make sure that the power LED is on.
If the power LED does not turn on after several minutes, make sure that the AC adapter is plugged in correctly and that the AirStation is turned on.

Mounting the AirStation on a Ceiling or Wall

The AirStation can be mounted to a ceiling or wall. The location where you mount the AirStation should meet the following requirements:

- Mount in a location with an ambient temperature range from 0°C (32°F) to 45°C (113°F), humidity from 10% to 90%, and no condensation.
- Do not bring the AirStation into close contact with other devices, other walls, or other objects.
- Do not mount on wobbly surfaces, slanted surfaces, or other unstable locations.
- Do not mount in locations that are exposed to direct sunlight, heat sources, or electromagnetic waves.
- Mount in a firm and stable position. If the AirStation is not properly mounted, it can fall and cause an accident.

Use the supplied accessories below to mount the AirStation to the ceiling or wall.

- Ceiling-mounting screws (large)
- Wall-mounting screws (medium)

Note: The ceiling where the AirStation is mounted must be capable of supporting a weight of at least 1.5 kg (3 lb 5 oz). If the ceiling does not have sufficient strength, be sure to reinforce the ceiling before securing the AirStation to it. If the ceiling is not reinforced, the AirStation can fall and cause an injury.

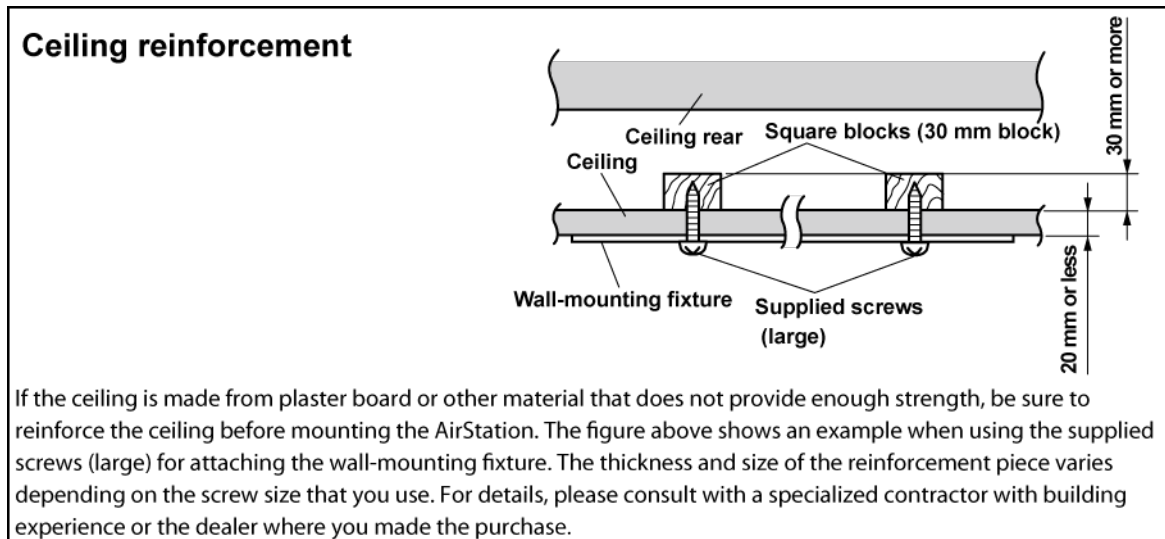

If the screws cannot be properly secured to the wall, such as when the wall material is thin, drill holes in the wall instead, embed the wall-mounting anchors, and secure the AirStation with the screws.

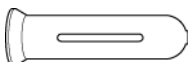

1 Use the four screws to secure the bracket.

Note: For certain environments, you may be able to use items other than the supplied screws. Select the most suitable item for use on your mounting surface.

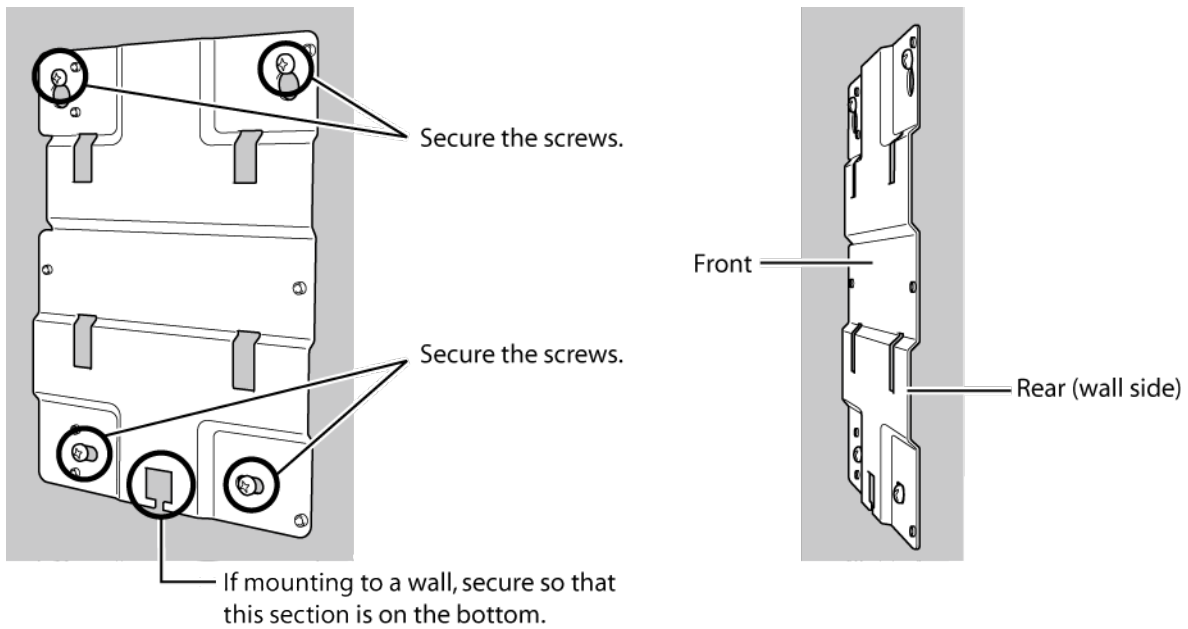

2 Press the AirStation onto the bracket, then push it down until it clicks into place.

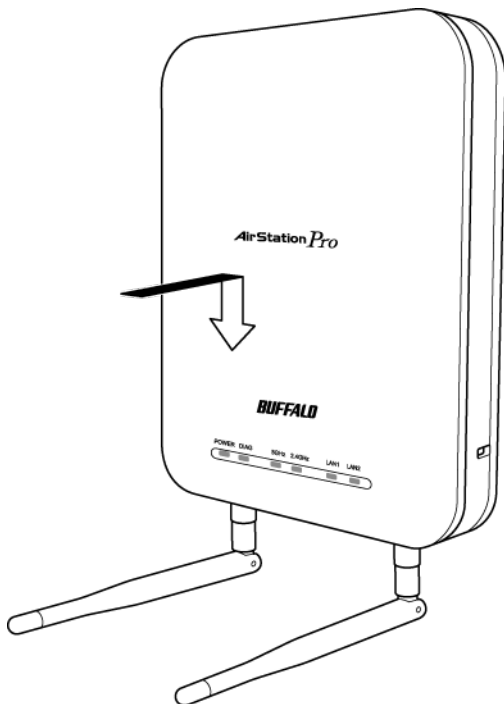

Mounting the Security Case

An optional security case (sold separately) is available for the AirStation. Follow the steps below to mount it.

- 1 Use the four screws to secure the bracket.

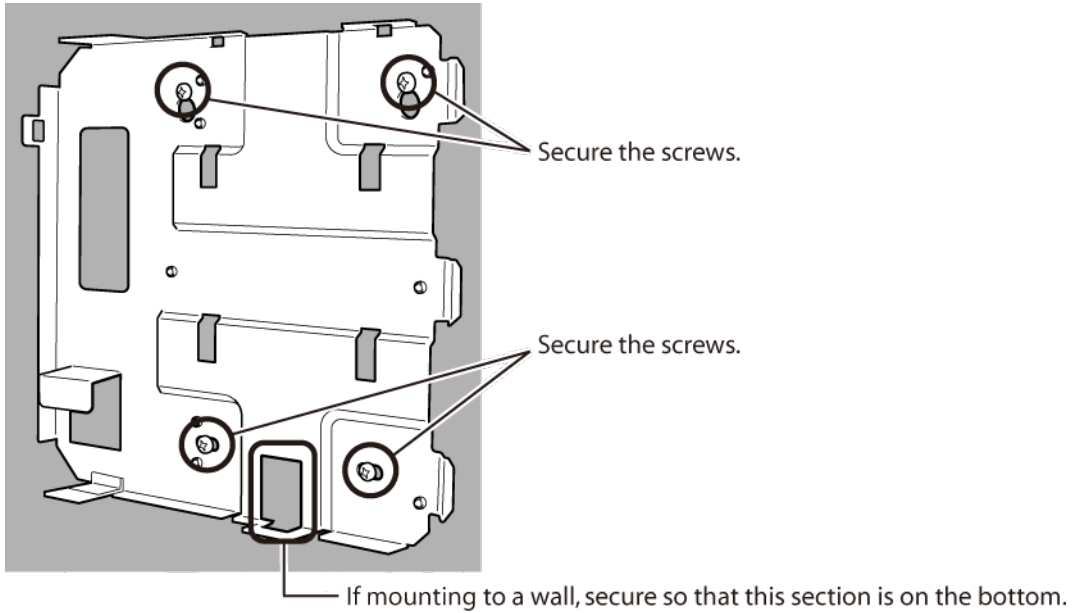

- 2 Press the AirStation onto the bracket, then push it down until it clicks into place.

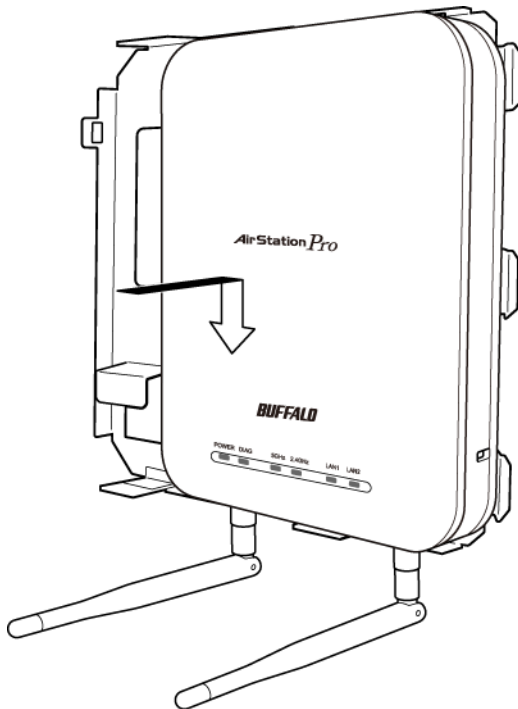

3 Insert the key into the cover and turn to the “open” position.

4 As shown in the figure, attach the cover at an angle.

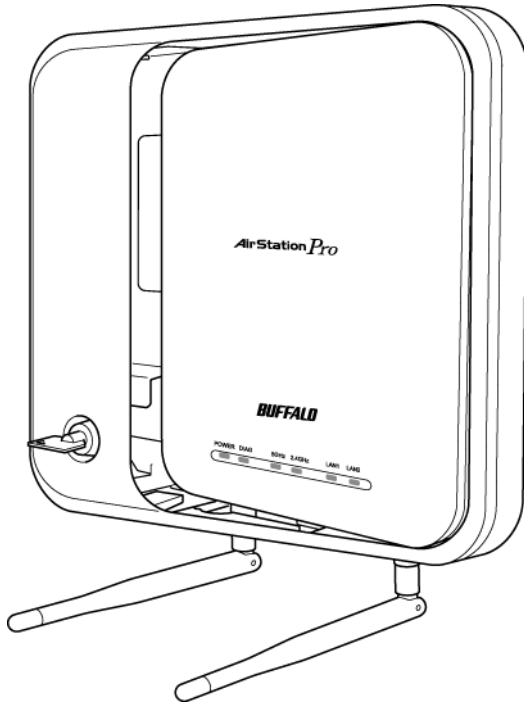

5 Turn the key to the “close” position and then remove it.

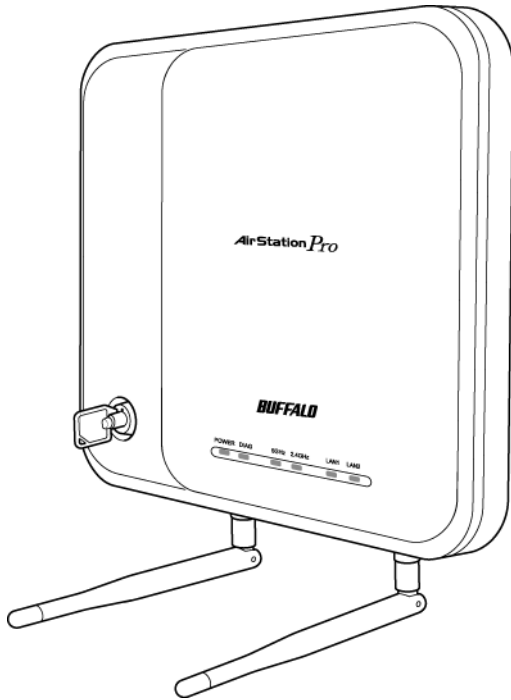

Removing the AirStation

To remove the AirStation from the mounting bracket, follow the procedure below.

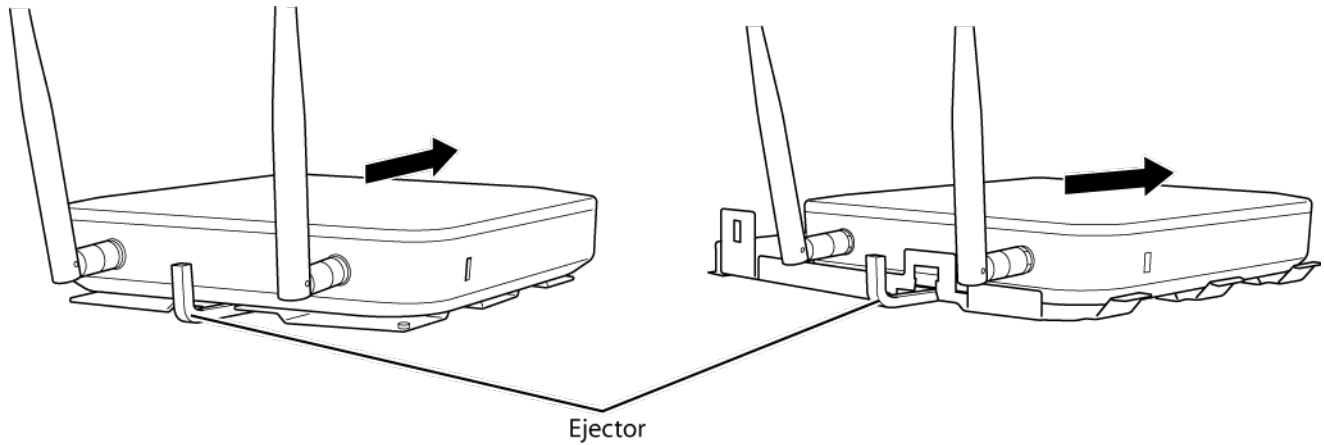

Insert the ejector key to raise the locking clips, then gently slide the AirStation off in the direction shown.

If the AirStation is difficult to remove, twist the ejector key 45 degrees to raise the locking clips a little more, then slide the AirStation off the bracket.

Initial Setup

The AirStation Configuration Tool lets you configure your AirStation easily. Download it from one of the links below:

WAPS-APG600H:

<http://d.buffalo.jp/waps-apg600h/>

WAPS-AG300H:

<http://d.buffalo.jp/waps-ag300h/>

Note: The AirStation Configuration Tool is intended for use with a Windows computer with Internet Explorer 8.0 or later installed. To configure the AirStation from a Mac or Linux computer, log in to Settings.

Setting the AirStation's IP Address

- 1 Start the AirStation Configuration Tool.
Click *Start - All Programs - BUFFALO - AirStation Utility - AirStation Configuration Tool*.
- 2 Click *Next*.

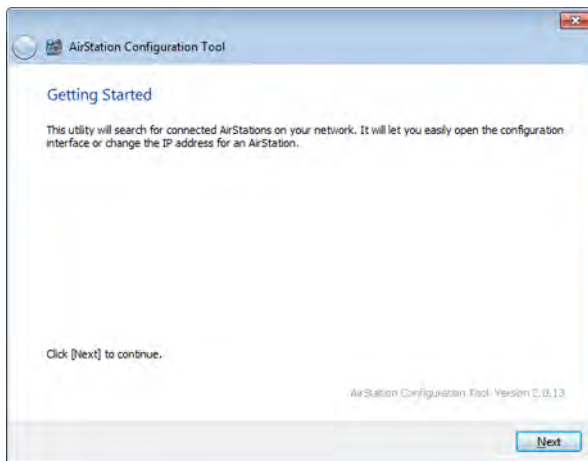

3 Select the AirStation to configure, then click *Next*.

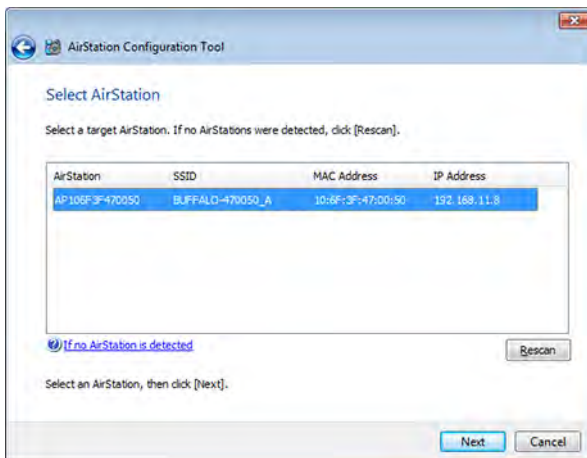

4 Click *Change IP Address*.

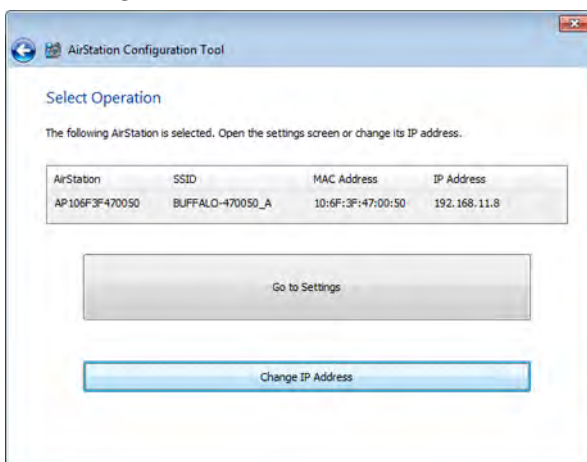

5 Enter the AirStation's IP address and click *Next*.



- 6 Enter the AirStation's admin password (the default is "password") and click *Next*.

Note: If the admin password contains 9 characters or more, the IP address of the AirStation cannot be changed using this procedure. In this case, open Settings and set the IP address.

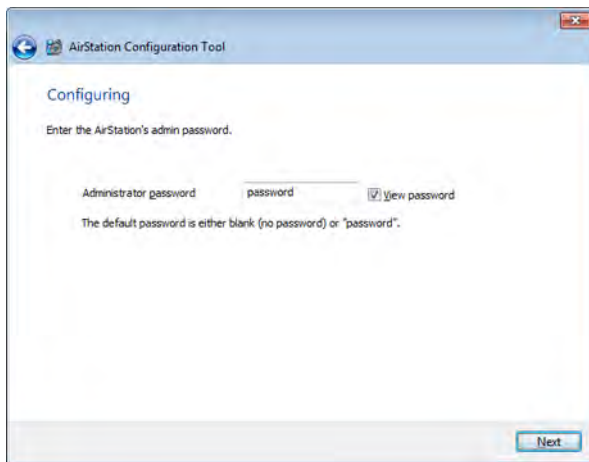

- 7 Click *Finish*.

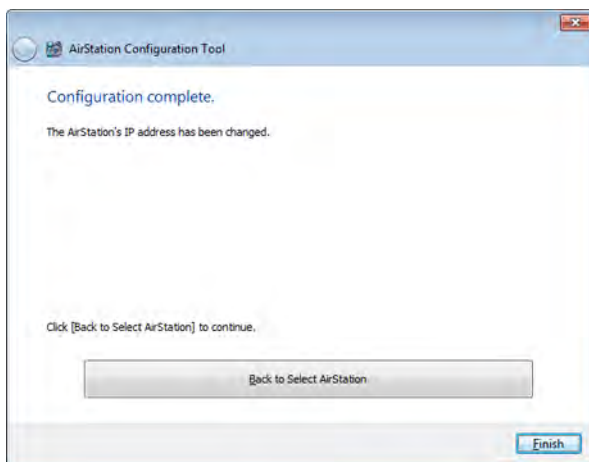

Settings

- 1 Start the AirStation Configuration Tool.
Click *Start - All Programs - BUFFALO - AirStation Utility - AirStation Configuration Tool*.

2 Click *Next*.

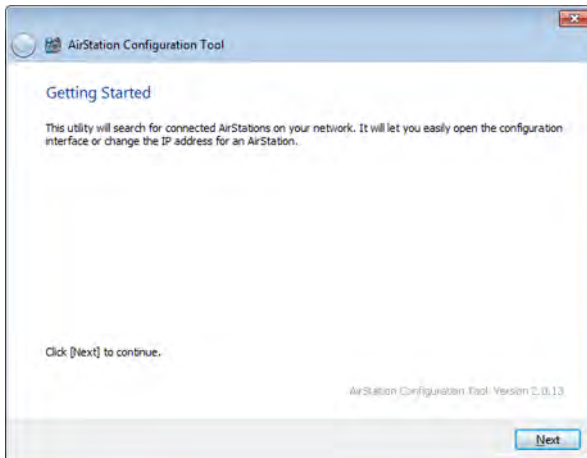

3 Select the AirStation to configure, then click *Next*.

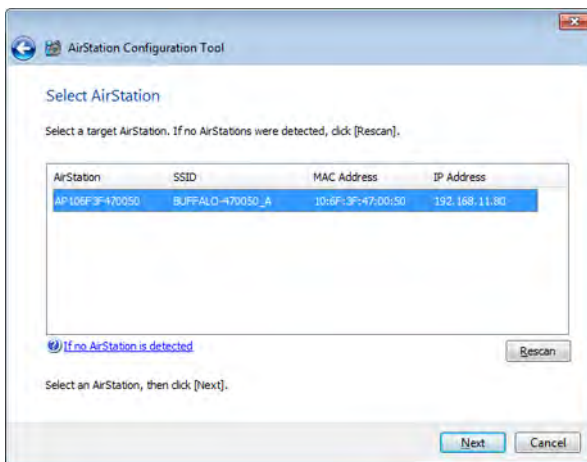

4 Click *Go to Settings*.

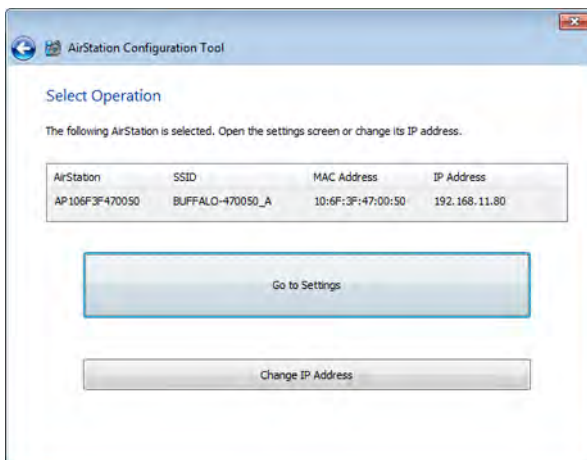

5 Click *OK*.

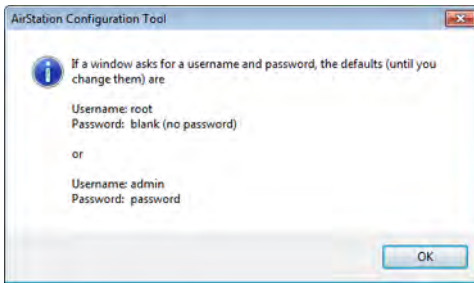

6 To log in to Settings, enter “admin” for the username and “password” for the password. Click *OK*.

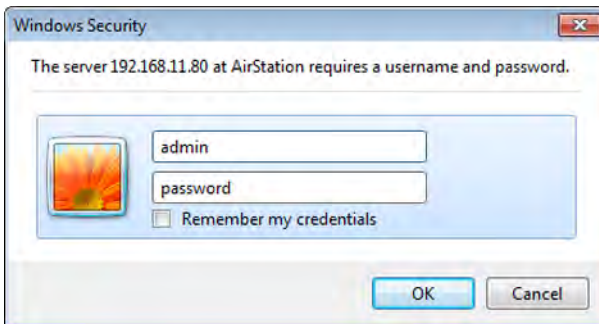

7 Settings will open.

Wireless & Encryption

By default, the AirStation’s wireless LAN is disabled. To configure it, follow the procedure below.

Note: This example uses WPA2-PSK AES encryption.

1 Open Settings.

2 Click *Encryption*.

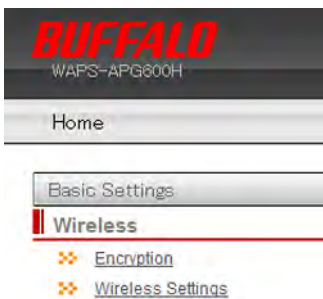

- 3** For the WAPS-APG600H, select “11a and 11g”.
For the WAPS-AG300H, select “11g” or “11a”.

Encryption Level (WEP/TKIP/AES)

Wireless Security Settings

Choose which wireless band to configure encryption for.

Wireless band	11a and 11g	
Each wireless band may be configured	11g	separately.
	11a	

- 4** Select the security mode (example: “WPA-PSK”).

Choose an encryption level for this connection.

Security Mode	No authentication
	No authentication
	WEP
	IEEE802.1x/EAP
	WPA-PSK
	WPA-EAP

Back

- 5** Select “WPA2 Only” for the WPA type, “AES” for the encryption type, set the pre-shared key, and click *Apply*.

Choose an encryption level for this connection.

Security Mode	WPA-PSK
WPA Type	WPA2 Only
Encryption Type	AES
Pre-shared Key Type	Passphrase
Pre-shared Key	12345678901234567890

TKIP: TKIP is an encryption method which is somewhat more secure than WEP.

AES: AES is the most secure wireless encryption currently available. It is highly recommended if all your clients support it.

WPA-PSK/WPA2-PSK: WPA-PSK and WPA2-PSK use a password (“pre-shared key”) to authenticate wireless clients.

Back Apply

Changing the Password

To change your AirStation's settings, you'll need to log in to Settings. The default username is "admin" and the default password is "password". After initial setup is complete, it is highly recommended that you change the password as described below.

- 1 Open Settings.
- 2 Click *Advanced*.

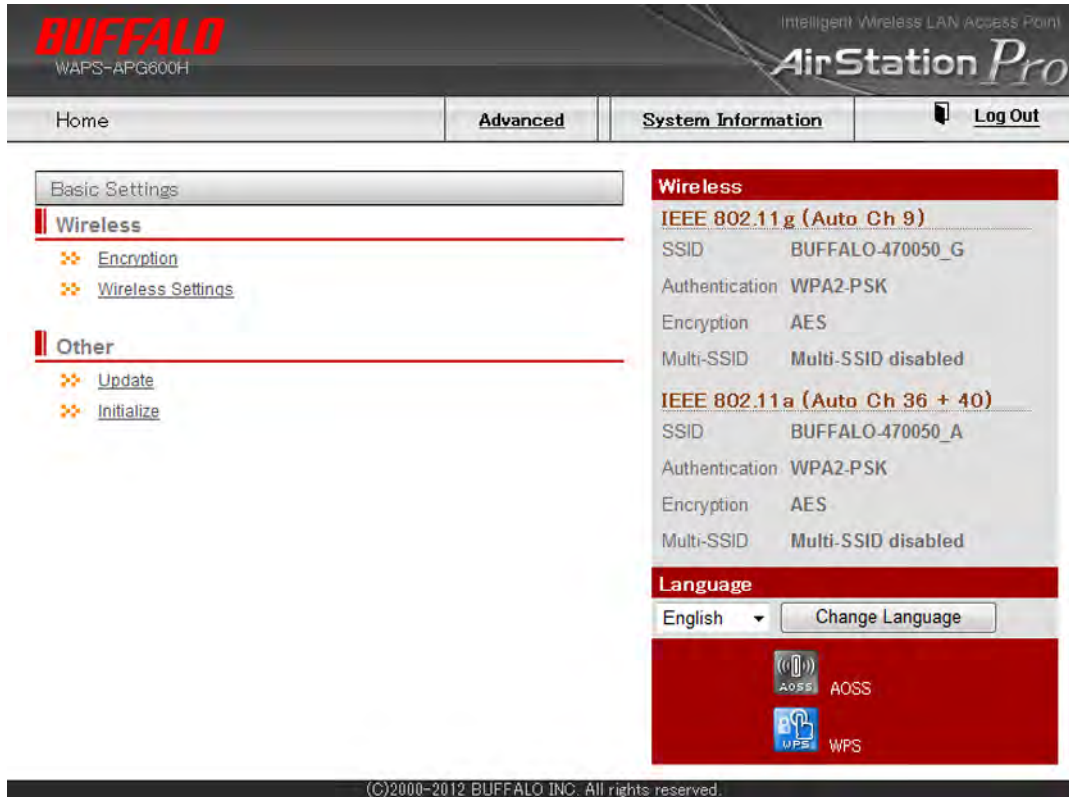

- 3 From the left-side menu, click *Administration - Username and Password*.

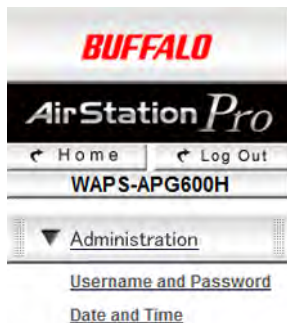

4 Enter a new administrator password (twice) and click *Apply*.

Username and Password

This is the account to manage this router.

Administrator Name	admin
Administrator Password	•••••••• •••••••• (Confirm)
Username	user
Password	•••••••• ••••~•••• (Confirm)

Notes:

- The administrator password should contain between 6 and 32 single-byte alphanumeric characters and symbols.
- Passwords should contain between 6 and 32 single-byte alphanumeric characters and symbols.
- Passwords cannot be blank.
- If you log in as “admin”, all AirStation settings can be changed.
- If you log in as “user”, you can view settings but not change them.

Chapter 3 - Configuration

Settings

Settings is a browser-based GUI where you may configure the AirStation and monitor the network.

Home

The menu is displayed on the left side of the screen and system information is displayed on the right side. The descriptions in the following pages show screens from the WAPS-APG600H.



Encryption	Configure the wireless LAN encryption here.
Wireless Settings	Change the SSID, wireless channel, and operational mode here.
Update	Update the AirStation's firmware here.
Initialize	Initialize the AirStation's settings here.

LAN Settings

LAN-side IP Address

Configure the LAN-side IP addresses here.

LAN Settings - LAN-side IP Address

LAN-side IP Address Settings

LAN-side IP Address

IP Address Assignment	DHCP Client	▼
IP Address	192.168.11.100	
Subnet Mask	255.255.255.0	
Default Gateway	From DHCP	▼

DNS Servers

Primary Address	From DHCP	▼	
Secondary Address	From DHCP	▼	

Apply

IP Address Assignment	Choose the method for obtaining the IP address.
IP Address	Enter the IP address when IP address assignment is set to "Static IP Address".
Subnet Mask	Enter the subnet mask when IP address assignment is set to "Static IP Address".
Default Gateway	Configure the default gateway. Enter the IP address when IP address assignment is set to "Static IP Address".
Primary Address	Configure the primary DNS server. Enter the IP address when IP address assignment is set to "Static IP Address".
Secondary Address	Configure the IP address of the secondary DNS sever. Enter the IP address when IP address assignment is set to "Static IP Address".

LAN Port

Configure the wired LAN port here.

LAN Settings - LAN Port

LAN-side Ethernet Settings

Wired LAN Port Settings

Wired LAN Port	Enable	Speed & Duplex	MDI	Flow Control	802.3az
Wired Port (#1)	Enabled ▾	Auto ▾	Auto ▾	Enabled ▾	Enabled ▾
Wired Port (#2)	Enabled ▾	Auto ▾	Auto ▾	Enabled ▾	Enabled ▾

Apply

Wired LAN Port	Displays the port number of the wired LAN port.
Enable	Select whether to enable or disable the wired LAN port.
Speed & Duplex	Select the communication speed of the wired Ethernet connection. Normally, use "Auto". If the connected device cannot be automatically recognized, try to use another one.
MDI	Select the communication status (straight-through or crossover connection) of the AirStation with the connected device. "Auto" is recommended for most users.
Flow Control	Select whether to enable or disable flow control. If flow control is enabled, overflows of the receive-side buffer are detected and a specific frame is sent to enable send-side restriction.
802.3az	Select whether to enable or disable IEEE802.3az EEE. When enabled, the power supplied to the LAN port can be limited when data is not flowing. Note: The connected device must support IEEE802.3az EEE for this to work properly.

VLAN

Configure the VLAN settings for the wired and wireless LAN here. Don't change VLAN settings unless you know what you're doing!

LAN Settings - VLAN

VLAN

Interface VLAN

Wired LAN Port	VLAN Mode	VLAN ID	Additional VLAN ID
Wired Port (#1)	Untagged ▼	1	
Wired Port (#2)	Untagged ▼	1	
Wireless 11g	VLAN Mode	VLAN ID	Additional VLAN ID
SSID [BUFFALO-470050_G]	Untagged ▼	1	
Wireless 11a	VLAN Mode	VLAN ID	Additional VLAN ID
SSID [BUFFALO-470050_A]	Untagged ▼	1	

Management VLAN

VLAN ID	1
---------	---

Apply

VLAN Mode	<p>Select the VLAN mode of the wired LAN port (#1, #2) and each SSID (when wireless is enabled). One of the VLAN modes below can be selected.</p> <p>Tagged This sends or receives frames with a tag (compliant with IEEE 802.1Q). VLAN networks that contain different IDs can be relayed.</p> <p>Untagged This receives only frames that have not been tagged. The specified VLAN ID is added to the received frames, and they are transferred to another LAN port.</p> <p>Multiple This receives only frames that have not been tagged. The specified VLAN ID and 1 additional VLAN ID can be transferred to another LAN port.</p>
VLAN ID	<p>Enter a specific VLAN ID to the interface VLAN. An integer value from 0 to 4094 can be set for the VLAN ID. You can enter a value in this field only when "Untagged" or "Multiple" is selected for VLAN mode.</p>
Additional VLAN ID	<p>Enter an additional VLAN ID to the interface VLAN. An integer value from 0 to 4094 can be set for the additional VLAN ID. You can enter a value in this field only when "Multiple" is selected for VLAN mode.</p>

Management VLAN ID	<p>Sets the VLAN ID of the management VLAN. An integer value from 0 to 4094 can be set for the VLAN ID.</p> <p>Note: Limitations are placed on the values that can be set to the management VLAN ID for enabling access to the management VLAN from the wired LAN. One of the conditions below must be satisfied.</p> <ul style="list-style-type: none"> • If all wired ports are untagged ports, the VLAN ID of one of the ports must be the same as the management VLAN ID. • One of the wired ports is a tagged port.
---------------------------	---

Network

Proxy ARP

Configure Proxy ARP settings here. Proxy ARP enables the wireless client to improve the performance and power saving feature.

Network - Proxy ARP

Proxy ARP

Proxy ARP	<input type="text" value="Disabled"/>
Proxy ARP Aging Time	<input type="text" value="300"/> (60-86400 seconds)

Proxy ARP	If enabled, Proxy ARP will work for all VLAN. Disabled by default.
Proxy ARP Aging Time	Select how long to retain the ARP information monitored by Proxy ARP. Set an interval at least twice as long as the ARP request interval of the wireless client. Values of 60-86400 seconds can be set. The default value is 300 seconds.

Bridge

Configure bridge parameters here.

Network - Bridge

Bridge Settings

Rapid STP	<input type="radio"/> On <input checked="" type="radio"/> Off
Aging Time	300 (1-86400 seconds)
BPDU Forwarding	Enabled
Bridge Priority	32768 (0-61440)
Forward Delay	15 (4-30 seconds)
Max Age	20 (6-40 seconds)
Transmit Hold Count	6 (1-10)
Auto Edge	Disabled

Bridge Port Settings

Wired LAN Port	Port Priority	Path Cost	Edge Port	Point to Point
Wired Port (#1)	128	20000	Disabled	Auto-select
Wired Port (#2)	128	20000	Disabled	Auto-select

Apply

Rapid STP	Select whether to enable or disable rapid spanning tree. The default is "Off".
Aging Time	Set the time to hold MAC address learned by frame forwarding of the bridge. If the network configuration is changed frequently, try to set smaller value to shorten the time of relearning. 1-86400 seconds can be set. The default value is 300 seconds.
BPDU Forwarding	Select whether to enable or disable BPDU forwarding. Enabled by default.
Bridge Priority	Configure the priority to recognize the bridge in the spanning tree. Normally, duplicate ID can be in the same network. The bridge device which has the smallest priority in the network works as the "root bridge".
Forward Delay	Set the time to reconfigure the bridge. Smaller value makes reconfiguration faster. If the network is massive, the reconfiguration may not be able to finish by the set time. 4-30 seconds can be set. The default value is 15 seconds. Note: This setting is enabled when the AirStation is working as the root bridge. If it is not the root bridge, this setting is ignored.
Max Age	Select how long before the AirStation automatically reconfigures the bridge once it stops receiving BPDU frames. 6-40 seconds can be set. The default value is 20 seconds. Note: This setting is enabled when the AirStation is working as the root bridge. If it is not the root bridge, this setting is ignored.
Transmit Hold Count	Specify the maximum number of BPDUs sent in 1 second. 1-10 can be entered. The default value is 6.
Auto Edge	Select whether to enable or disable Auto edge. If enabled, the port which does not receive BPDUs for 3 seconds works as the edge port. Disabled by default.

Bridge Port Settings	<p>Configure the information for each port. This information enables the spanning tree protocol to calculate the best route to reconfigure the bridge.</p> <p>Port Priority</p> <p>Set the priority of each port. Smaller values are prioritized if the path cost of each port is the same. You may enter up to 240. The default value is 128.</p> <p>Path Cost</p> <p>Set the cost for the frame forwarding of each port. Generally, configure the cost depending on wired or wireless device standard communication rate. In spanning tree protocol, the route whose total cost is lowest is actually used. 1-200000000 can be entered. The default value is 20000 for wired ports, 200000 for wireless ports.</p> <p>Edge Port</p> <p>Select whether to enable or disable edge port. Edge port is effective when you connect a device which does not have any bridge to the port. After the connection, you can communicate immediately. Disabled by default.</p> <p>Point to Point</p> <p>If enabled, ports connect one-to-one to the other bridge. The default is "Auto-select".</p>
-----------------------------	---

Wireless Settings

AOSS

You can make detailed changes to AOSS settings here.

Wireless Settings - AOSS

AOSS



Start AOSS



Stop AOSS

AOSS Settings

AOSS Button on the AirStation: Enabled

Allowed Bands: 11a and 11g

WEP Authentication

802.11g: Disabled

802.11a: Disabled

TKIP Authentication

802.11g: TKIP/AES mixed mode

802.11a: TKIP/AES mixed mode

VLAN	VLAN Mode	VLAN ID	Additional VLAN ID
802.11g (AES/TKIP)	Untagged	<input type="text" value="1"/>	<input type="text"/>
802.11g (WEP)	Untagged	<input type="text" value="1"/>	<input type="text"/>
802.11a (AES/TKIP)	Untagged	<input type="text" value="1"/>	<input type="text"/>
802.11a (WEP)	Untagged	<input type="text" value="1"/>	<input type="text"/>

Encryption (802.11g)

Encryption Type	AES
SSID	224877FE27EAB1EE1EAFBB806E73DF77
Encryption Key	63e24c13007d994e4e6937348b87f050cb50ce3449579e54a13c640d933b2e0
Encryption Type	TKIP
SSID	63C8E19B210949254EE07D2131BDBF9C
Encryption Key	78c234997b8f35df30581e45c3c74eec2b1458393cba14c2bd37a64136e6
Encryption Type	128-bit WEP
SSID	499B3C2837159314600F50BA269F4CA4
Encryption Key	647429082DAF5218B2DFDF65F F444E9653FE942132B5EDFD07D 2651024F6521EB61527798407A 3D7aCF23E7F31B20073565E009
Encryption Type	64-bit WEP
SSID	00817E69519694177167FF551E20210F
Encryption Key	7E58B89145 F2F8E92CCF 41CD090823 F9D7E34311

Encryption (802.11a)

Encryption Type	AES
SSID	74209CF2523267006871FFCA384F51E0
Encryption Key	12c731539ca8976f48f14a37295a1a5a68f1eb1b56acd44ef07624f1debd11
Encryption Type	TKIP
SSID	068FFC4B51C2343B4CDB567E72564D6F
Encryption Key	f5115438075c7a29553cae61fc30af3928e34e054134049282012e3dd22
Encryption Type	128-bit WEP
SSID	17784B4D651ECFEF05FD5D1D7C1DE43E
Encryption Key	D8BF21F4E62B691F7D5E253E1F F2FF0812502BC7EBB1A5A445E 982221C7241F0852367DA4D8D DBED07CD7A35D725AB9F3604E9
Encryption Type	64-bit WEP
SSID	4C5134EA3C1322F81D999806150EE288
Encryption Key	F3ED9CEC19 642D48F908 4B04E3258A 1C3B52AE54

AOSS Clients

Client Information	MAC Address	Supported Encryption	Connection Settings	Operation
SC-02B	B4:07:F9:EF:38:41	64-bit WEP/128-bit WEP/TKIP/AES(802.11g)	Allow (-)	<input type="button" value="Deny connection"/> <input type="button" value="Delete"/>

Start AOSS	Click the button to start the AOSS connection.
Stop AOSS	Displayed when AOSS is in use. Click this button to disconnect the AOSS connection. This disconnects from all connected wireless LAN devices. AOSS clients information and AOSS connected device information will be erased.
AOSS Settings	<p>AOSS Button on the AirStation Select whether to enable or disable physical AOSS/WPS button on the AirStation. If disabled, the AOSS connection does not start even when the AOSS/WPS button on the AirStation is pressed.</p> <p>Allowed Bands Select the band(s) to use AOSS.</p> <p>WEP Authentication The encryption system for an AOSS device that uses the WEP encryption level can be specified. 64-bit WEP and 128-bit WEP are provided as encryption systems with 64-bit length and 128-bit length WEP keys respectively. If "Disabled" is selected, the WEP encryption is disabled.</p> <p>TKIP Authentication The encryption system for an AOSS device that uses the TKIP encryption level can be specified. If "TKIP/AES mixed mode" is selected, both TKIP and AES can be used for the unicast encryption system. (TKIP is used for the multicast encryption system regardless of the unicast encryption system.)</p> <p>VLAN The VLAN mode, the VLAN ID, and the additional VLAN ID of the device connected by AOSS can be specified. When AOSS is started, the same VLAN as the management VLAN ID is assigned, but this can be changed manually to any user-selected ID. The additional VLAN ID can be specified only when "Multiple" is selected as the VLAN mode.</p>
Encryption	<p>The encryption level used by AOSS and the detailed security information is displayed for each wireless LAN interface standard. When the AirStation is connected to a wireless device that does not support AOSS, set this information manually to the wireless device. The 802.11a and 802.11g standards each have different security information.</p> <p>Encryption Type Displays currently available encryption levels.</p> <p>SSID Displays SSID corresponding to each encryption level. Only the SSID for the currently-set encryption level is used.</p> <p>Encryption Key Displays currently available encryption key.</p>
AOSS Clients	<p>Client Information Displays the names of the wireless devices connected by AOSS.</p> <p>MAC Address Displays the MAC addresses of the connected wireless devices.</p> <p>Supported Encryption Displays all the encryption levels corresponding to the wireless devices connected by AOSS.</p>

Notes:

- When AOSS or WPS starts, all other operations are disabled until the setup process is complete.

- If AOSS or WPS connection is not established after 3 minutes, the AirStation will cancel setup and return to normal.
- Up to 24 wireless devices can be connected with AOSS. Settings configured by AOSS can't be modified. To change the settings, either run AOSS again or disable AOSS and configure settings manually.
- AOSS is disabled by default.
- To connect a non-AOSS device to a network configured with AOSS, enter the SSID and key in the device's settings manually.
- If SSID 1 is configured, its settings will be used by AOSS configuration. The following security settings will not be used:
WPA2-PSK AES
WPA2-PSK TKIP
WPA2-PSK TKIP/AES mixed mode
- AOSS can't be used if the SSID 1 encryption key contains spaces or 64 hexadecimal characters.

WPS

You can make detailed changes to WPS settings here.

Wireless Settings - WPS

WPS (Wi-Fi Protected Setup)

WPS Enable

Apply

WPS

Airstation PIN 12345670

Push-button WPS

WPS by PIN

WPS Security

WPS Status Configured (AOSS)

11g

SSID 70C8BFBD335947AF67C2C81711FE45DE

Encryption Type WPA/WPA2-PSK TKIP/AES mixed mode

Encryption Key 4c40b17808d3060b1a37373a701d3522d289190b5544050bd4401f2796312f4

11a

SSID 4BC547931FC471D43444DFD72AF55B62

Encryption Type WPA/WPA2-PSK TKIP/AES mixed mode

Encryption Key d3106d1dde33567b16760805386e220a2ff9b62500c53a1039dbe9073d1e527

WPS	Select whether to enable or disable WPS (Wi-Fi Protected Setup).
AirStation PIN	Displays the PIN code of the AirStation. Click <i>Generate PIN</i> to generate a new PIN code.
Push-button WPS	Click <i>Start</i> to start WPS.

WPS by PIN	After you enter the PIN code and click <i>Start</i> , the internal registrar of the AirStation waits 2 minutes for the connection request from the enrollee with the PIN code.
WPS Status	Displays “Configured” or “Not configured”. “Configured” is displayed if all currently-available wireless bands are configured. “Not configured” is displayed if any wireless bands are not configured.
SSID	Displays the SSID used in WPS. This is not displayed when the WPS status is “Not configured”.
Encryption Type	Displays the encryption method used by WPS. This is not displayed when the WPS status is “Not configured”.
Encryption Key	Displays the encryption key used by WPS. This is not displayed when the WPS status is “Not configured”.

The setting items for IEEE802.11g and IEEE802.11a are grouped together in this explanation.

Basic

Configure the basic information for wireless LAN here.

Wireless Settings - 802.11g or 802.11a - Basic

Basic (11g)

Wireless	<input checked="" type="radio"/> Enable <input type="radio"/> Disable			
Band	11b/g/n ▼			
Enable SSID#	1 ▼			
#	SSID	VLAN Mode	VLAN ID	Additional VLAN ID
1	BUFFALO-470050_G	Untagged ▼	1	
Auto Channel	<input checked="" type="radio"/> Enable <input type="radio"/> Disable			
Auto Channel Range	Ch 1 - 11 ▼			
Auto Channel Interval	Half hour ▼			
	<input type="checkbox"/> Change channel even if clients are connected			
Channel Bandwidth	20 MHz ▼			
BSS Basic Rate Set	1,2,5,11 Mbps ▼			
Multicast Rate	Auto ▼			

Apply Cancel

Wireless	Select whether to enable or disable wireless LAN.
Band	This is used to set the wireless mode. To set manually, select “User-defined”. In communication with devices that are set as WDS connection devices, the transmission speed is determined automatically regardless of the user-defined setting.
Enable SSID#	Specify enabled number of the SSIDs from SSID1 to SSID5. You may specify up to 5 SSIDs each for 11g and 11a.

SSID1 - SSID5	<p>Enter the SSID and select the VLAN mode. Enter the VLAN ID, and if "Multiple" is selected as the VLAN mode, enter the additional VLAN ID. A roaming environment can be built by installing multiple AirStations with the same SSID over a wide area.</p> <p>1 to 32 single-byte alphanumeric characters and single-byte symbols can be entered. It is case-sensitive. The VLAN ID and the additional VLAN ID can be set to an integer value from 0 to 4094.</p> <p>Note: To set SSID2 to SSID5, enable the numbers corresponding to "Enable SSID#".</p>
Auto Channel	<p>Select whether to enable or disable auto-channel. When enabled, vacant channels can be automatically detected.</p>
Auto Channel Range	<p>Specify the channel range used in the 2.4 GHz or 5 GHz band wireless LAN.</p>
Channel	<p>Specify the channel used in the 2.4 GHz or 5 GHz band wireless LAN. If there are any wireless devices using a nearby frequency in the surrounding area, communication can be adversely affected. If the communication speed is slow, try changing the channel.</p> <p>Note: If W53 (52, 56, 60, or 64 ch) or W56 (100, 104, 108, 112, 116, 120, 124, 128, 132, 136, or 140 ch) is selected, DFS (dynamic frequency selection) is automatically enabled to prevent crosstalk with weather and flight control radar and similar equipment. When enabled, if the AirStation detects crosstalk, wireless communication may be temporarily stopped for about 1 minute to prevent interference with radar.</p>
Auto Channel Interval	<p>Specify the interval for changing the channel when auto-channel is enabled. When "Change channel even if clients are connected" is checked, the channel is changed even if the client is connected to the AirStation.</p>
Channel Bandwidth	<p>Specify the channel bandwidth.</p>
BSS Basic Rate Set	<p>Select the communication speed of the management and control communication frame for the AirStation and wireless device.</p> <p>The following speeds are available in the 802.11g standards:</p> <ul style="list-style-type: none"> • 1, 2 Mbps • 1, 2, 5.5, 11 Mbps (selected by default) • 1, 2, 5.5, 6, 11, 12, 24 Mbps <p>all (1, 2, 5.5, 11, 12, 18, 24, 36, 48, 54 Mbps)The following speeds are available in the 802.11a standards:</p> <ul style="list-style-type: none"> • 6, 12, 24 Mbps (selected by default) <p>all (6, 9, 12, 18, 24, 36, 48, 54 Mbps)If communication cannot be performed when set to "all", return to the default setting.</p>
Multicast Rate	<p>This setting controls the communication speed of multicast packets. When set to "Auto", the communication speed is determined automatically for maximizing the coverage distance.</p> <p>802.11g Auto, 1, 2, 5.5, 6, 9, 11, 12, 18, 24, 36, 48, or 54 Mbps can be selected.</p> <p>802.11a Auto, 6, 9, 12, 18, 24, 36, 48, or 54 Mbps can be selected.</p> <p>Because the multicast communication speed and coverage distance are inversely proportional to each other, this setting is recommended only when necessary.</p>

Advanced

Configure the detailed information for the wireless LAN here.

Wireless Settings - 802.11g or 802.11a - Advanced

Advanced (11g)

Contention Slot	Short ▾
Preamble Type	Long ▾
Guard Interval	Short GI ▾
Aggregation	AMPDU ▾
802.11g Protection	<input checked="" type="radio"/> Enable <input type="radio"/> Disable
802.11n Protection	<input checked="" type="radio"/> Enable <input type="radio"/> Disable
DTIM Period	1 (1-255)
RTS Threshold	2347 (1-2347)
Fragment Threshold	2346 (256-2346)
Tx Power	100% ▾
Beacon Interval	100 (20-1000 ms)
Station Keepalive Interval	60 (0-65535 seconds)
SM Power Save	Disabled ▾

Apply Cancel

Contention Slot	Select "Short" or "Long". If "Short" is selected, the communication speed may be improved, but connection may not be possible to wireless devices that do not support short slot time. Make the same setting for the connected wireless devices. This option is not available in 802.11a.
Preamble Type	Select "Long" or "Short". If "Short" is selected, the communication speed may be improved, but connection may not be possible to wireless devices that do not support short preamble. Make the same setting for the connected wireless devices. This option is not available in 802.11a.
Guard Interval	Select the encoding format during frame sending. "Long GI" arranges the encoding with a certain amount of time or space to prevent interference. "Short GI" shortens this interval to send more information.
Aggregation	To improve the transmission rate, multiple transmission frames are aggregated into one frame. The AirStation supports AMSDU and AMPDU.
802.11g Protection	If enabled, communication with 11g devices can be given priority even in environments where 11g and 11b wireless LAN devices coexist. This option is not available in 802.11a.
802.11n Protection	If enabled, collisions and other adverse effects on performance can be reduced even in environments where devices using previous bands (11a, 11b, 11g) coexist.
DTIM Period	This interval is how often the AirStation sends power management information to wireless devices. Larger values may reduce power consumption, but might cause slower responses. This setting is ignored if the power management setting in the wireless device (computer) is disabled.

RTS Threshold	This performs a RTS/CTS process before sending frames with a size that exceeds the threshold value. This enables improved reliability in frame transfers when the surrounding environment is poor, where separated from the AirStation by considerable distance, or other adverse conditions.
Fragment Threshold	Frames with a size larger than this threshold value are broken up before sending. This improves reliability of frame transfers when the wireless environment is poor, when separated from the AirStation by considerable distance, or other adverse conditions.
Tx Power	Specify the output power when the AirStation performs wireless transmission.
Beacon Interval	Enter the interval for sending beacons. If the interval is long, wireless communication performance may be improved, but the capability of the wireless device to detect the AirStation will be reduced. Normally, usage at the default value is recommended.
Station Keepalive Interval	Specify the interval for confirming whether the AirStation is connected to the wireless device. Normally, this setting can be used at the default value (60), but in some wireless devices, setting a larger value enables more stable communication and reduced power consumption. When set to 0, the connection is not confirmed by the AirStation, but in environments where a large unspecified number of wireless devices are connected, a new wireless device may be unable to make a connection.
SM Power Save	This enables reduced power consumption in devices when communicating with 11n standard wireless devices that have two or more transmission systems (11n2x or later). If "Enabled (Static)" is selected, communication with the AirStation always uses one transmission system. Because power does not need to be supplied to other transmission systems, this enables maximum power efficiency. If "Enabled (Dynamic)" is selected, the AirStation can request the receiving wireless device to use the second or later transmission system if needed. Unless it is needed, power does not need to be supplied to more than one transmission system, and this enables the providing of both high-speed communication and power saving.

Security

Configure wireless LAN security information here.

Wireless Settings - 802.11g or 802.11a - Security

Security (11g)	
SSID	BUFFALO-470070_G ▾
Broadcast SSID	Enable ▾
Wireless Client Isolation	Disable ▾
Load Balancing	25 /25
Authentication Method	WPA-PSK ▾
WPA Type	WPA/WPA2 mixed mode-PSK ▾
Encryption Type	TKIP/AES mixed mode ▾
Key Renewal Interval	60 minute(s)
Pre-shared Key Type	Passphrase ▾
Pre-shared Key	<input type="text"/>
Additional Authentication	No additional authentication ▾

SSID	Choose which SSID you will be changing settings for.
Broadcast SSID	When enabled, you can search for the AirStation.
Wireless Client Isolation	<p>Restricts communication between wireless client devices connected to the same SSID.</p> <p>STA separator Prohibits communication between all wireless devices connected using this wireless standard.</p> <p>SSID separator Prohibits communication to wireless devices except those connected to the same SSID.</p> <p>Disable No restrictions are placed on communication between wireless devices. Note: The wireless client isolation does not prohibit communication that passes through WDS (repeater) or wired LAN ports. Therefore, communication that passes through wireless device proxies cannot be restricted.</p>
Load Balancing	Specify the maximum number of wireless devices that can be simultaneously connected to the AirStation.

<p>Authentication Method</p>	<p>Select the authentication method used for wireless device connection.</p> <p>No authentication The AirStation does not request authentication.</p> <p>WEP This performs the authentication compliant with WEP. A fixed-length encryption key (shared key) must be set in both the AirStation and wireless device. WPS should be disabled.</p> <p>IEEE802.1x/EAP This performs the authentication compliant with IEEE802.1x/EAP. Both this and the RADIUS server can be used together to use the wireless LAN only for users who have the account.</p> <p>WPA-PSK This performs the authentication compliant with WPA (Wi-Fi Protected Access) and WPA2. Communication can be performed only by wireless devices that were set with the same pre-shared key.</p> <p>WPA-EAP This performs the compliant with WPA (Wi-Fi Protected Access) and WPA2. Both of RADIUS server and wireless device (supplicant) should be compatible with the EAP authentication protocol.</p>
<p>Additional Authentication</p>	<p>Select an additional authentication for connecting a wireless device.</p> <p>No additional authentication The AirStation does not request additional authentication when a wireless device is connected.</p> <p>MAC address filters Restrictions are made for enabling connections only by wireless devices with pre-registered MAC addresses.</p> <p>MAC filtering & MAC RADIUS authentication Restricts access using a registered MAC address list and RADIUS authentication. A compatible RADIUS server is required for MAC RADIUS authentication.</p> <p>MAC RADIUS authentication When a wireless device is connected, authentication is performed using the MAC address of the device. A compatible RADIUS server is required for MAC RADIUS authentication.</p>

Authentication Method: WEP

<p>Key Length</p>	<p>Select an encryption key length between 64-bit or 128-bit.</p>
<p>Key Type</p>	<p>This is used to select the encryption key format.</p> <p>ASCII (5 characters) Enter 5 single-byte alphanumeric characters (key length: 64-bit) or 13 characters (key length: 128-bit).</p> <p>Hex (10 characters) Enter 10-digit hexadecimal characters (key length: 64-bit) or 26-digit characters (key length: 128-bit).</p>
<p>Default key</p>	<p>The encryption key that is used can be selected from Key 1 to Key 4.</p>

Encryption Key 1 Encryption Key 2 Encryption Key 3 Encryption Key 4	Enter the encryption key specified in “Key Type”.
--	---

Authentication Method: IEEE802.1x/EAP

Key Length	Select an encryption key length between 64-bit or 128-bit.
-------------------	--

Authentication Method: WPA-PSK

WPA Type	WPA/WPA2 mixed mode-PSK Wireless device authentication by both WPA-PSK and WPA2-PSK can be performed simultaneously. WPA2 Only This performs the authentication compliant with WPA2 (IEEE802.11i). WPA Only This performs the authentication compliant with WPA (Wi-Fi Protected Access).
Encryption Type	TKIP/AES mixed mode TKIP and AES authentication and communication can be performed simultaneously. TKIP is used for broadcast and multicast communication. TKIP TKIP is an encryption method with enhanced security features. AES AES is an encryption method that uses a strong algorithm for encryption.
Key Renewal Interval	Enter the interval to update the encryption key.
Pre-shared Key Type	This is used to select the pre-shared key format. Passphrase The key is entered using 8 to 63 single-byte alphanumeric characters. Hex (64 characters) The key is entered using 64 hexadecimal digits.
Pre-shared Key	Enter the pre-shared key specified in “Pre-shared Key Type”.

Authentication Method: WPA-EAP

WPA Type	WPA/WPA2 mixed mode-EAP Wireless device authentication by both WPA-EAP and WPA2-EAP can be performed simultaneously. A RADIUS server and wireless device (supplicant) compliant with the EAP authentication protocol are required. WPA2-EAP This performs wireless device authentication compliant with WPA2 (IEEE802.11i). WPA-EAP This performs wireless device authentication compliant with WPA (Wi-Fi Protected Access).
-----------------	---

Encryption Type	<p>TKIP/AES mixed mode</p> <p>TKIP and AES authentication and communication can be performed simultaneously. TKIP is used for broadcast and multicast communication.</p> <p>TKIP</p> <p>TKIP is an encryption method based on the WEP system with enhanced security features. WPS should be disabled.</p> <p>AES</p> <p>AES is an encryption method that uses a strong algorithm for encryption.</p>
Key Renewal Interval	Enter the interval to update the encryption key.

Clients

Displays information on the wireless devices communicating with the AirStation.

Wireless Settings - 802.11g or 802.11a - Clients

WLAN Client Table

Interface	MAC Address	Tx	Rx	RSSI (dBm)	Connected Time	Idle Time
BUFFALO-470050_G	80:BE:05:2A:D7:34	0 Bytes	3.4 KBytes	-35/-38	5 secs	0

WDS Clients

Interface	MAC Address	Tx	Rx	RSSI (dBm)	Idle Time
-----------	-------------	----	----	------------	-----------

Refresh

Interface	The SSID of wireless devices communicating with the AirStation.
MAC Address	The MAC addresses of wireless devices communicating with the AirStation.
Tx	The data size (bytes) sent to wireless devices communicating with the AirStation.
Rx	The data size (bytes) received from wireless devices communicating with the AirStation.
RSSI (dBm)	The signal strength (dBm) of wireless devices communicating with the AirStation.
Connected Time	The continuous connection time of wireless devices communicating with the AirStation.
Idle Time	The time since wireless devices began communicating with the AirStation.

WDS

Configure the repeater (WDS) that connects AirStations wirelessly here.

Wireless Settings - 802.11g or 802.11a - WDS

WDS (11g)

WDS Mode

WDS Functionality	Disabled
Local MAC Address	10:6F:3F:47:00:50
<input type="button" value="Apply"/>	

Configuration WDS Peer

Wireless MAC Address of WDS Peer	<input type="text"/>
VLAN Mode	Untagged port <input type="text"/> VLAN ID <input type="text"/>
Encryption	None
<input type="button" value="Add"/>	

Registered Access Point

MAC Address	Encryption Type	VLAN ID	Action
AA:BB:CC:AA:BB:CC	No Encryption	1	<input type="button" value="Delete"/> <input type="button" value="Edit"/>
<input type="button" value="Delete All"/>			

WDS Functionality	Select whether to enable or disable WDS. To use WDS, WDS must also be set at the other connected AirStation. Disabled WDS is not in use. WDS with AP WDS is in use. Dedicated WDS Dedicated WDS is in use. Dedicated WDS does not accept communication from normal wireless devices.
Local MAC Address	The AirStation's MAC address.
Wireless MAC Address of WDS Peer	Enter the MAC address of the access point communicating by WDS.

VLAN Mode	<p>Configure the network ID of the VLAN associated with this WDS connection.</p> <p>Untagged Defined as an untagged LAN port. The AirStation transfers only network communication frames with a preset VLAN ID to this LAN port. The VLAN ID must be set at the same time.</p> <p>Tagged Defined as the tagged LAN port. The AirStation transfers all network communication frames to this LAN port. During this transfer, a VLAN tag compliant with IEEE802.1Q is inserted.</p>
VLAN ID	<p>This must be set only when “Untagged” is specified for the VLAN mode. This specifies the VLAN network associated with the WDS connection. Communication with networks and LAN ports having different VLAN numbers is not possible.</p>
Encryption	<p>Specify the encryption protocol used for the WDS connection.</p> <p>None No encryption is configured for communication in WDS connections. This setting is not recommended.</p> <p>WEP WEP is used for communication in WDS connections. A fixed-length encryption key (shared key) must be set in both the WDS sending and receiving AirStations.</p> <p>AES AES is used for communication in WDS connections. To use AES, a preshared key (PSK) must be set in both the WDS sending and receiving AirStations.</p>
Registered Access Point	<p>Displays a list of the MAC addresses of access points connected by WDS.</p> <p>Edit Click to edit the access point information.</p> <p>Delete This removes individual access point information.</p> <p>Delete All This removes all access point information.</p>

RADIUS

Configure the RADIUS server used for wireless LAN device authentication and other operations here.

In the AirStation, IEEE802.11g and IEEE802.11a can each be registered to 2 (primary and secondary) external RADIUS servers. When the primary and secondary servers are registered, if a communication problem occurs in the primary server, the inquiry target can be automatically switched to the secondary server for continuing the authentication process.

Note: The RADIUS server must be capable of being accessed from the management VLAN.

Wireless Settings - RADIUS

RADIUS Settings

RADIUS Server (11g)

Primary RADIUS Server	
RADIUS Server	<input type="text"/>
Authentication Port	1812
Shared Secret	<input type="text"/>
Session Timeout	3600 second(s)
Accounting	<input checked="" type="radio"/> Enable <input type="radio"/> Disable
Accounting Port	1813

Secondary RADIUS Server	
RADIUS Server	<input type="text"/>
Authentication Port	1812
Shared Secret	<input type="text"/>
Session Timeout	3600 second(s)
Accounting	<input checked="" type="radio"/> Enable <input type="radio"/> Disable
Accounting Port	1813

RADIUS Server (11a)

Primary RADIUS Server	
RADIUS Server	<input type="text"/>
Authentication Port	1812
Shared Secret	<input type="text"/>
Session Timeout	3600 second(s)
Accounting	<input checked="" type="radio"/> Enable <input type="radio"/> Disable
Accounting Port	1813

Secondary RADIUS Server	
RADIUS Server	<input type="text"/>
Authentication Port	1812
Shared Secret	<input type="text"/>
Session Timeout	3600 second(s)
Accounting	<input checked="" type="radio"/> Enable <input type="radio"/> Disable
Accounting Port	1813

Apply

Cancel

RADIUS Server

Enter the IP address of the RADIUS server that makes the inquiry during authentication.

Authentication Port	Enter the UDP port number of the RADIUS server where the RADIUS authentication protocol is used. Generally, the port number 1812 is used in the RADIUS system.
Shared Secret	The shared secret used in communication between the RADIUS server and AirStation is set from 1 to 255 characters. Authentication can be accepted only from devices that have the same shared secret as the RADIUS server.
Session Timeout	Enter the time (0 to 86400 seconds) that communication can be performed for wireless devices allowed by the RADIUS server. If 0 is set, the time that communication can be performed is unlimited. If a session timeout attribute is also set to the referred RADIUS server, the AirStation is used with priority to the value that was set to the RADIUS server.
Accounting	Select whether to enable or disable RADIUS accounting protocol which tallies packet information of authorized clients on the RADIUS server. If your RADIUS server is not compatible with RADIUS accounting protocol, disable this. Disabled by default.
Accounting Port	Enter server-side UDP port for RADIUS accounting protocol. Generally, the default value (1813) is used.

MAC Filtering

MAC filtering lets you restrict access your network. Only specific wireless devices will be able to connect.

Notes:

- You can enter the MAC address like the following.
1234567890AB (No delimiter)
12:34:56:78:90:AB (Colon delimiter)
12-34-56-78-90-AB (Hyphen delimiter)
- You can register up to 256 MAC addresses.

Wireless Settings - MAC Filtering

MAC Filtering

Add MAC Addresses

MAC Address Filtering Table

MAC Address	Action
00:11:22:11:22:11	<input type="button" value="Delete"/>

Add MAC Addresses	Enter a MAC address or multiple MAC addresses to add to the MAC address filtering table.
MAC Address Filtering Table	Displays a list of the MAC addresses where connection is allowed under the MAC access restrictions. Delete Click to delete the MAC addresses. Delete All Click to delete all MAC addresses. Backup Click to save a text file with the name "wl_acl_list.txt" containing the MAC addresses to your PC.

WMM

Assign priority to VoIP and streaming data here. Use this setting for communication that requires real-time responsiveness (such as VoIP and other streaming communication) to minimize the effects of other communication. Use the same QoS configuration and settings for all devices on the network.

Wireless Settings - WMM

WMM

QoS Configuration

QoS

WMM-EDCA Settings

WMM Parameters of Access Point				
	CWMin	CWMax	Aifsn	Txop
AC_BK	4	10	7	0
AC_BE	4	6	3	0
AC_VI	3	4	1	94
AC_VO	2	3	1	47

WMM Parameters of Station				
	CWMin	CWMax	Aifsn	Txop
AC_BK	4	10	7	0
AC_BE	4	10	3	0
AC_VI	3	4	2	94
AC_VO	2	3	2	47

QoS	<p>Select whether to enable or disable QoS.</p> <p>Disable No priority is assigned for any communication. All frames are processed in order of input.</p> <p>Enable Priority control is performed using WMM-EDCA for communication between the AirStation and the wireless device. QoS must be enabled at both the AirStation and wireless device sides. All communication with unsupported devices and broadcast or multicast communication is performed at the priority "AC_BE".</p>
------------	--

WMM-EDCA Settings: In normal use, these settings do not need to be changed.

WMM Parameters	The default values for the access point (AirStation) and station (wireless client device) are shown below.			
	Priority	Parameters	AP	STA
	AC_BK (Low)	CWmin	4	4
		CWmax	10	10
		Aifsn	7	7
		Txop	0	0
AC_BE (Nomal)	CWmin	4	4	
	CWmax	6	10	
	Aifsn	3	3	
	Txop	0	0	
AC_VI (High)	CWmin	3	3	
	CWmax	4	4	
	Aifsn	1	2	
	Txop	94	94	
AC_VO (Highest)	CWmin	2	2	
	CWmax	3	3	
	Aifsn	1	2	
	Txop	47	47	
<p>CWmin, CWmax This sets the maximum and minimum values of the contention window. The contention window is used in the frame collision avoidance mechanism that is performed in IEEE802.11, and generally, smaller values in the window result in a higher likelihood that the queue will obtain sending rights.</p> <p>AIFSN The AIFS number controls the period a wireless node has to wait before it is allowed to transmit its next frame. The units are slots (the window defined by CWmin and CWmax). A shorter AIFS period means a message has a higher probability of being transmitted with low latency, which is important for streaming video and voice data.</p> <p>TXOP The transmit opportunity is the period of time that a station can send frames. Each unit is 32 ms. Longer TXOP periods may increase network speeds for a device, but may make other devices on the network seem unresponsive.</p>				

Wireless Monitor

Displays information about wireless clients connected to the AirStation.

Wireless Settings - Wireless Monitor

Wireless Monitor

Wireless 11g

Ch	SSID	MAC Address	Security	RSSI (dBm)	Type
1	BBS_g	4C:E6:76:0B:A4:00	WPA1PSKWPA2PSK/TKIPAES	100	11b/g/n
1	4C:E6:76:0B:A4:02	4C:E6:76:0B:A4:02	WPA1PSKWPA2PSK/TKIPAES	100	11b/g/n
1	ApArt	4C:E6:76:0B:23:50	WPA2PSK/TKIP	42	11b/g/n
1	4CE676AEA3E0	4C:E6:76:AE:A3:E0	WPA1PSKWPA2PSK/TKIPAES	78	11b/g/n
1	nas_dhcp_g	10:6F:3F:0E:63:6E	WPA1PSKWPA2PSK/TKIPAES	89	11b/g/n
1	Buffalo-G-795C	B0:C7:45:29:79:5D	WPA2PSK/AES	47	11b/g/n
1	VERISERVE-Priter	00:24:A5:BC:CE:CD	WPA1PSKWPA2PSK/TKIPAES	89	11b/g/n
1	0024A5C043DA_G	00:24:A5:C0:43:DA	WPA1PSKWPA2PSK/TKIPAES	73	11b/g/n
1	4C:E6:76:0B:A4:01	4C:E6:76:0B:A4:01	WPA1PSKWPA2PSK/TKIPAES	100	11b/g/n
1	GL04P-24DBAC438D39	24:DB:AC:43:8D:39	WPA1PSKWPA2PSK/TKIPAES	100	11b/g/n
8	BUFFALO-AA023C_G	10:6F:3F:86:89:A8	WPA2PSK/AES	83	11b/g/n

Wireless 11a

Ch	SSID	MAC Address	Security	RSSI (dBm)	Type
----	------	-------------	----------	------------	------

Refresh

Wireless 11g

Wireless 11a

Displays detected wireless client information.

Ch: Displays channels of each SSIDs.

SSID: Displays SSIDs of detected wireless clients.

MAC Address: Displays MAC addresses of detected wireless clients.

Security: Displays encryption methods of detected wireless clients.

RSSI (dBm): Displays the signal strength of detected wireless clients.

Type: Displays available wireless bands of detected wireless clients.

EZ Analyzer

This function is currently disabled and will remain so until the optional antenna is released.

EZ Analyzer

EZ Analyzer Disabled

Administration

Username and Password

This is where you configure the AirStation's username, password, and name (hostname).

Administration - Username and Password

Username and Password

Account to Manage This Router

Administrator Name	<input type="text" value="admin"/>
Administrator Password	<input type="password" value="••••"/>
	<input type="password" value="••••"/> (Confirm)
Username	<input type="text" value="user"/>
Password	<input type="password" value="••••"/>
	<input type="password" value="••••"/> (Confirm)

Advanced Settings

AirStation Name	<input type="text" value="AP106F3F470070"/>
Management Protocol	<input checked="" type="checkbox"/> HTTP <input checked="" type="checkbox"/> HTTPS <input type="checkbox"/> SNMP
SNMP Version	<input type="text" value="v1/v2c"/>
SNMP Get Community	<input type="text" value="public"/>
SNMP Set Community	<input type="text" value="private"/>
SNMP Trap	<input type="text" value="Disabled"/>
SNMP Trap Community	<input type="text" value="public"/>
SNMP Trap Manager	<input type="text"/>

Administrator Name	The name of the administrator account may contain 4-16 single-byte alphanumeric characters and hyphens (-). Don't use a hyphen as the first or last character.
Administrator Password	The administrator password may contain 6-32 single-byte alphanumeric characters and symbols.
Username	This user can view settings but not change them. The username may include 4-6 single-byte alphanumeric characters and hyphens (-). Don't use a hyphen as the first or last character.
Password	The password for the non-administrator user may contain 6-32 single-byte alphanumeric characters and symbols.
AirStation Name	This name is used for syslog and other network functions. It may contain up to 32 single-byte alphanumeric characters and hyphens (-). Don't use a hyphen as the first or last character.

Management Protocol	<p>The Settings interface may be accessed through a web browser by normal or encrypted protocol.</p> <p>HTTP HTTP access is recommended for trusted networks only.</p> <p>HTTPS HTTPS encrypts communication for use with any network.</p> <p>SNMP If enabled, the router can be configured using SNMP management software.</p>
SNMP Version	<p>Different versions of SNMP are only partially compatible. Configure this setting to match the version of SNMP that your management software uses.</p> <p>v1/v2c Use this setting with managers that support SNMPv1 or SNMPv2c. To access MIB, use a (Get/Set/Trap) community.</p> <p>v3 Use this setting with managers that support SNMPv3 USM (MD5 authentication and DES encryption). To read MIB (get), use "administrator name and password" or "username and password". To write MIB (Set), use "administrator name and password". Note: For v3, use a password with at least 7 characters.</p>
SNMP Get Community	Enter the community name (6-32 characters) that is specified when "GETRequest" is sent by the SNMP manager to the AirStation.
SNMP Set Community	Enter the community name (6-32 characters) that is specified when "SET Request" is sent by the SNMP manager to the AirStation.
SNMP Trap	Select whether to enable or disable trap transmission with the AirStation's SNMP agent. Disabled by default.
SNMP Trap Community	Enter the community name (6-32 characters) that is used to send "Trap Notification" to the SNMP manager. The default value is "public".
SNMP Trap Manager	Specify the destination host to which "Trap Notification" is sent. SNMP manager of the destination host must be working. The default value is blank.

Date and Time

Configure the AirStation's internal clock here. The date and time, NTP server, and time zone can be set for the internal clock.

Note: The AirStation doesn't have a backup battery, so date and time will return to their default values anytime the AirStation is turned off or restarted. Using of an NTP server to set time and date automatically is recommended.

Administration - Date and Time

Date and Time

Date and Time Settings

Local Time	Year	2012	Month	Jan	Day	1
	Hours	0	Minutes	21	Seconds	28

Acquire Current Time from Your PC

NTP Time Server

Use NTP	<input type="checkbox"/> Enable
Server Name	<input type="text"/>
Update Interval	24 hours

Time Zone

Time Zone: (GMT+09:00) Osaka, Sapporo, Tokyo

Apply Cancel

Date and Time Settings	Setting date and time incorrectly may result in intermittent network issues. Currently, dates from 2005 to 2037 are supported. Using an NTP server is recommended.
Acquire Current Time from Your PC	Configures the AirStation with the current time and date from your PC.
Use NTP	Check to enable NTP functionality.
Server Name	Enter either the hostname or IP address of the NTP server. Use an IP address if DNS is not configured.
Update Interval	Specify how often the NTP server will be queried. Enter an interval from 1 to 24 hours.
Time Zone	Choose a time zone for the AirStation's internal clock.

Transfer Logs to Syslog Server

Configure the transfer functionality using syslog protocol here.

Administration - Transfer Logs to Syslog Server

Transfer Logs to Syslog Server

Transfer Logs	<input type="checkbox"/> Enable Syslog Server <input type="text"/>
Copy Logs to Attached USB Device	<input type="checkbox"/> Enable

Transfer Logs	Check to enable the log information transfer functionality. When enabled, enter the IP address of the syslog server.
Copy Logs to Attached USB Device	Check to enable transferring logs information to a USB memory device attached to the AirStation.

Admin Tools

Displays the status of Admin Tools.

Administration - Admin Tools

Admin Tool Settings

Status	Unregistered	<input type="button" value="Revoke Registration"/>
Policy Groups	<input type="text"/>	

Status	<p>If "Registered" is displayed, remote management mode by admin tools is enabled. Certain parameters and content that can be set from this interface may be partially restricted.</p> <p>If "Unregistered" is displayed, remote management mode by admin tools is not enabled.</p> <p>Revoke registration Click to cancel remote management mode in admin tools.</p>
Policy Groups	Displays the group of the managed parameters when the AirStation is in the remote management mode.

Save/Restore Settings

Lets you back up the current settings or restore settings from the backup file.

Administration - Save/Restore Settings

Save/Restore Settings

Restore Method

Restore from a file on your PC
 Restore from a file on the USB device

No USB device connected.

Back Up Settings

Encrypt the configuration file with a password.

Restore Settings

Open file with password.

<p>Restore Method</p>	<p>Choose the method to restore settings from a backup file.</p> <p>Note: You cannot restore the configuration in these cases:</p> <ul style="list-style-type: none"> • You forgot the administrator password. • The backup file was saved with a newer version of the firmware. • The backup file was saved with a different model number or type of AirStation. • The backup file is corrupt.
<p>Back Up Settings</p>	<p>Save</p> <p>Click to save the current AirStation settings as a file.</p>
<p>Restore Settings</p>	<p>Browse...</p> <p>Click to select the backup file.</p> <p>Restore</p> <p>Click to start restoring from the backup file.</p> <p>Notes:</p> <ul style="list-style-type: none"> • The time is reset whether restoration succeeds or fails. • If a password is set for the backup file, check <i>Open file with password.</i> and enter the password.

Restart

Restarts the AirStation.

Administration - Restart

Restart

This will reboot the router. Your settings will not be changed.
Click "Restart" to restart the router now.

Restart

Restart	Click to restart the AirStation.
----------------	----------------------------------

Initialize

This initializes the AirStation settings.

Administration - Initialize

Initialize

This will restore all router settings to their factory defaults.

Initialize

Initialize	Click to initialize all the settings and restart the AirStation.
-------------------	--

Update Firmware

Update the firmware to obtain bug fixes, support for the latest functions, and other improvements.

Administration - Update Firmware

Update Firmware

Update firmware from a file on your PC
 a file on the attached USB device

No USB device connected.

Firmware Update File

You may download updated firmware files from Buffalo's website.

[Link to Buffalo's website](#)

Update firmware from	Select the location of the firmware update file; on your PC or on the attached USB device.
Firmware Update File	Select the firmware file. Browse... Click to select the firmware file. Update Click to start updating firmware. Notes: <ul style="list-style-type: none">• During the firmware update process, the LED on the AirStation blinks. Do not turn the power off while the firmware is being updated. After the process is completed, the AirStation restarts.• Do not use firmware files other than those provided by Buffalo.• To use a firmware file from a USB device, save the firmware file to the root folder and do not change the file name or extension.• An update error occurs if the firmware file is corrupted or if you attempt to write the firmware for a different model.• The date and time will be reset regardless of whether the firmware update is successful or fails.

LED Settings

Configure whether the AirStation LEDs are lit.

Administration - LED Settings

LED Settings

LED Settings

Power LED	<input checked="" type="radio"/> On <input type="radio"/> Off
LAN LED	<input checked="" type="radio"/> On <input type="radio"/> Off
Wireless LED	<input checked="" type="radio"/> On <input type="radio"/> Off
USB LED	<input checked="" type="radio"/> On <input type="radio"/> Off

Power LED	The power LED is turned off when "Off" is set.
LAN LED	The LAN 1 LED and LAN 2 LED are turned off when "Off" is set.
Wireless LED	The 5 GHz LED and 2.4 GHz LED are turned off when "Off" is set.
USB LED	The USB LED is turned off when "Off" is set.

Diagnostic

System Information

Displays a list of the main settings for the AirStation.

Diagnostic - System Information

System Information

System

Model	WAPS-APG600H
AirStation Name	AP106F3F470050
Boot from	Internal memory
Version	1.12.3
MAC Address	10:6F:3F:47:00:50
Management VLAN ID	1
IP Address	192.168.11.100 <input type="button" value="Refresh"/>
Default Gateway	---
DNS	---
DHCP Server	---

Wired LAN Port	Status	VLAN Mode / ID	Additional VLAN ID
Wired Port (#1)	Disconnected (---)	Untagged / 1	---
Wired Port (#2)	Connected (100 Mbps-Full-Duplex)	Untagged / 1	---

Wireless 11g

Status	Enabled
MAC Address	10:6F:3F:47:00:50
Channel	Ch 3 (Auto)
Transmit Power	100%

SSID	Authentication Method	Encryption Type	VLAN Mode / ID	Additional VLAN ID	Additional Authentication	Wireless Client Isolation
BUFFALO-470050_G	No authentication	No encryption	Untagged / 1	---	No additional authentication	Disabled

WDS Settings (11g)

Mode	Disabled
------	----------

MAC Address	Encryption Type	VLAN Mode / ID
No WDS entries.		

Wireless 11a

Status	Enabled
MAC Address	10:6F:3F:47:00:58
Channel	Ch 44 + 48 (Auto)
Transmit Power	100%

SSID	Authentication Method	Encryption Type	VLAN Mode / ID	Additional VLAN ID	Additional Authentication	Wireless Client Isolation
BUFFALO-470050_A	No authentication	No encryption	Untagged / 1	---	No additional authentication	Disabled

WDS Settings (11a)

Mode	Disabled
------	----------

MAC Address	Encryption Type	VLAN Mode / ID
No WDS entries.		

System

Model	Displays the product model name.
AirStation Name	Displays the AirStation's name.
Boot from	Displays startup device of the AirStation.
Version	Displays firmware version.
MAC Address	Displays the MAC address.
Management VLAN ID	Displays management VLAN ID.
IP Address	Displays AirStation's IP address.
Default Gateway	Displays the IP address of the default gateway.
DNS	Displays the IP address of the DNS server.
DHCP Server	Displays the IP address of the DHCP server.
Wired LAN Port	Displays the status of the wired port (#1) and wired port (#2).

Wireless

Status	Displays the wireless connection status.
MAC Address	Displays the MAC address.
Channel	Displays current channel.
Transmit Power	Displays output power setting.
SSID	Displays the SSID.
Authentication Method	Displays the authentication method.
Encryption Type	Displays the encryption type.
VLAN Mode / ID	Displays the VLAN mode and VLAN ID.
Additional VLAN ID	Displays the additional VLAN ID.
Additional Authentication	Displays the status of additional authentication.
Wireless Client Isolation	Displays wireless client isolation status.
WDS Settings	Displays the WDS status. If WDS is enabled, displays access points available for communication.

Packet Information

Displays communication statistics of this product and the status of each port.

Diagnostic - Packet Information

Communication Packet Information

Interface	Status	Transmit Packets	Receive Packets
Wired Port (#1)	Disconnected (---)	0	0
Wired Port (#2)	Connected (100 Mbps-Full-Duplex)	10428	8075
Wireless (11g) SSID1 [BUFFALO-470050_G]	144Mbps	0	0
Wireless (11a) SSID1 [BUFFALO-470050_A]	300Mbps	0	0

Refresh

Interface	<p>Displays interface names. “()” describes the number of the port for wired port, and wireless band for wireless SSID.</p> <p>Wired Port Displays wired port of this product.</p> <p>Wireless Displays each SSID if you are using multiple SSIDs.</p> <p>WDS Displayed when the WDS connection is established.</p>
Status	<p>Wired Port Displays connection status and transmission method.</p> <p>Wireless Displays transfer rate.</p> <p>WDS Displays signal strength and transfer rate.</p>
Transmit Packets	Displays the transmitted packet count.
Receive Packets	Displays the received packet count.

CPU Monitor

This will monitor the operational status and displays usage of the CPU by numbers and histogram.

Diagnostic - CPU Monitor

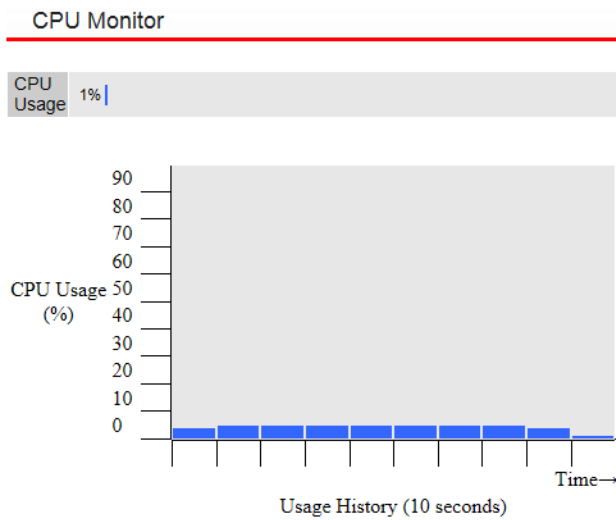

CPU Usage	Displays usage of the CPU by numbers and histogram.
------------------	---

I'm Here

This will cause your AirStation to beep. If you have multiple AirStations, this can make it easy to determine which one you're currently configuring.

Diagnostic - I'm Here

Duration of Sound	Specify the ring time. You may enter 1-300 seconds. The default value is 10 seconds.
--------------------------	--

Ping Test

A ping test checks whether the AirStation can communicate with a specific network device.

Diagnostic - Ping Test

Ping Test

Destination Address

Result

Destination Address	Enter the IP address or hostname of the device that you are testing communication with, then click <i>Execute</i> . The result will be displayed below.
Result	Displays the result of ping test.

Traceroute Test

A traceroute test checks where the packet goes through. A traceroute packet will be sent to the destination address and then this will display the result.

Diagnostic - Traceroute Test

Traceroute Test

Destination Address

Result

Destination Address	Enter the IP address or hostname of the device that you are testing communication with, then click <i>Execute</i> . The result will be displayed below.
Result	Displays the result of traceroute test.

USB

Displays the USB status.

Diagnostic - USB

USB

Port	USB
Device	RUF2-SC
Current	200mA
Status	

[Dismount](#)

Port	USB
Device	No USB device installed.
Current	----
Status	No USB device found.

Port	Displays the port name.
Device	Displays the USB device name.
Current	Displays the rated current consumption. It may differ from the actual current consumption.
Status	Displays the USB device's status.
Dismount	Click to dismount the USB device. Do not disconnect the USB device first without clicking this button or pressing USB eject button on the back of the unit.

Log

Displays log information in the AirStation.

Diagnostic - Log

Log

```
Nov 1 09:20:12 [SYSTEM]: WLAN[5G], BSS(rai0) WPS Send M1!  
Nov 1 09:17:02 [SYSTEM]: WLAN[5G], BSS(rai0) WPS Send M1!  
Nov 1 09:15:43 [SYSTEM]: WLAN[5G], BSS(rai0) WPS Send M1!  
Nov 1 09:12:38 [SYSTEM]: WLAN[5G], BSS(rai0) channel switch to 44  
Nov 1 09:12:33 [SYSTEM]: WLAN[2.4G], BSS(rai0) channel switch to 3  
Nov 1 09:12:26 [SYSTEM]: SNMP, stop SNMP server  
Nov 1 09:12:25 [SYSTEM]: WLAN[5G], WSC UPnP start  
Nov 1 09:12:25 [SYSTEM]: WLAN[5G], Channel = AutoSelect  
Nov 1 09:12:25 [SYSTEM]: WLAN[5G], CountryRegion = 1  
Nov 1 09:12:23 [SYSTEM]: WLAN[2.4G], WSC UPnP start  
Nov 1 09:12:22 [SYSTEM]: WLAN[2.4G], Channel = AutoSelect  
Nov 1 09:12:22 [SYSTEM]: WLAN[2.4G], CountryRegion = 1  
Nov 1 09:12:21 [SYSTEM]: SYSTEM, Apply settings for [Radio 24G][Radio 5G]  
Nov 1 09:11:18 [SYSTEM]: WLAN[2.4G], BSS(rai0) channel switch to 3  
Nov 1 09:11:08 [SYSTEM]: SNMP, stop SNMP server  
Nov 1 09:11:08 [SYSTEM]: WLAN[2.4G], WSC UPnP start  
Nov 1 09:11:08 [SYSTEM]: WLAN[2.4G], Channel = AutoSelect  
Nov 1 09:11:08 [SYSTEM]: WLAN[2.4G], CountryRegion = 1  
Nov 1 09:11:06 [SYSTEM]: SYSTEM, Apply settings for [Radio 24G]  
Nov 1 09:10:27 [SYSTEM]: WLAN[2.4G], BSS(rai0) WPS Send M1!  
Nov 1 09:09:43 [SYSTEM]: WLAN[2.4G], BSS(rai0) channel switch to 9  
Nov 1 09:09:33 [SYSTEM]: SNMP, stop SNMP server  
Nov 1 09:09:33 [SYSTEM]: WLAN[2.4G], WSC UPnP start  
Nov 1 09:09:32 [SYSTEM]: WLAN[2.4G], Channel = AutoSelect  
Nov 1 09:09:32 [SYSTEM]: WLAN[2.4G], CountryRegion = 1  
Nov 1 09:09:31 [SYSTEM]: SYSTEM, Apply settings for [Radio 24G]  
Nov 1 09:08:15 [SYSTEM]: WLAN[5G], BSS(rai0) WPS Send M1!  
Nov 1 09:07:30 [SYSTEM]: WLAN[2.4G](#0), STA(88:30:8a:6d:4d:78) had disassociated  
Nov 1 09:07:14 [SYSTEM]: WLAN[2.4G](#0), STA(88:30:8a:6d:4d:78) set key done in WPA2/W  
Nov 1 09:07:14 [SYSTEM]: WLAN[2.4G](#0), STA(88:30:8a:6d:4d:78) had associated succes
```

Save	Click to save logs as a text file named "logmsg.log".
Clear	Click to clear the log.
Refresh	Click to refresh the log.

Chapter 4 - Connect to a Wireless Network

Automatic Secure Setup (AOSS/WPS)

AOSS and WPS are systems that enable you to automatically configure wireless LAN settings. Just pressing the buttons will connect wireless devices and complete security settings. Use them to automatically connect wireless devices, computers, or game machines which support AOSS or WPS.



AOSS (AirStation One-Touch Secure System) was developed by Buffalo Inc. WPS was created by the Wi-Fi Alliance.

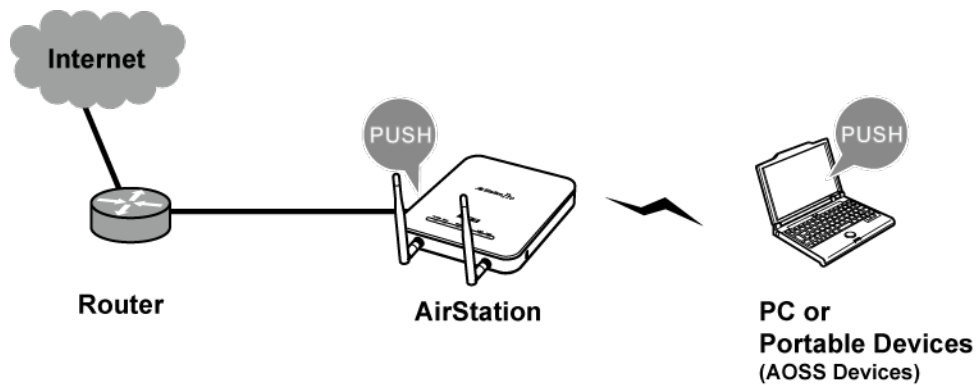

- Before using AOSS or WPS to connect the Buffalo wireless client to the computer, download Client Manager or AOSS Assistant from the Buffalo website and install it.
- Buffalo's Client Manager software can be used with the wireless LAN devices built into most computers. However, it is not guaranteed to work with all wireless LAN devices available. Some wireless clients may require manual setup.

Windows 8.1, Windows 8, Windows 7, or Windows Vista (Client Manager V)

If you are using Windows 8.1, Windows 8, Windows 7 or Windows Vista, use the Client Manager V to connect wirelessly with AOSS or WPS.

- 1 Launch Client Manager V.
- 2 Click *Create Profile*.

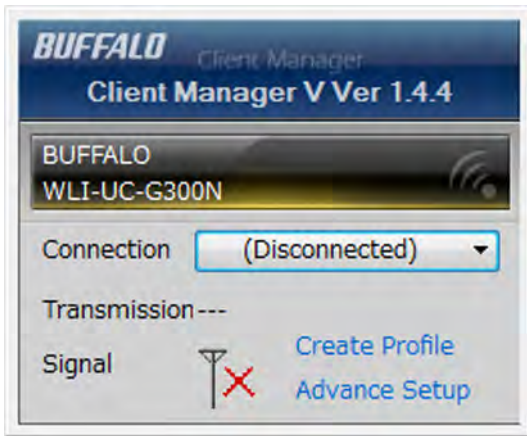

- 3 If the User Account Control screen opens, click *Yes* or *Continue*.
- 4 Click the *WPS AOSS* button.

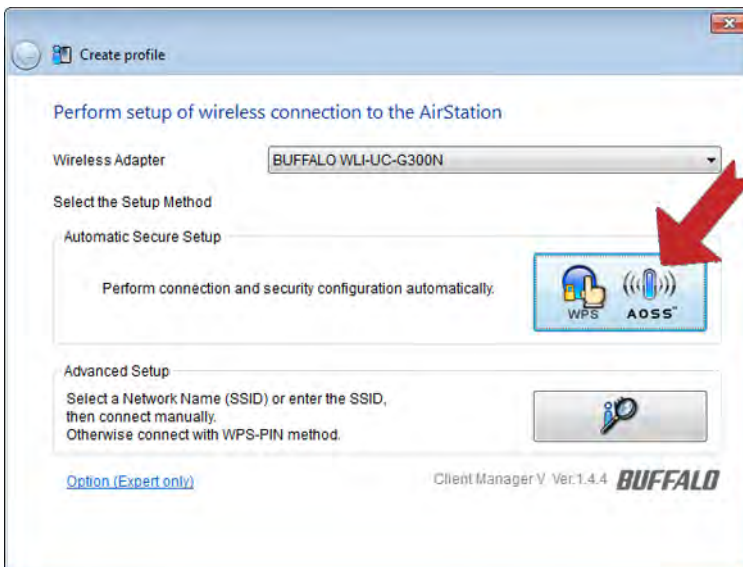

Follow any instructions displayed on the screen. When the 2.4 GHz and 5 GHz LEDs on the front of the AirStation stop flashing and are steadily lit, the connection is complete.

Windows XP (Client Manager 3)

If you are using Windows XP, use Client Manager 3 to connect wirelessly with AOSS or WPS.

- 1 Right-click  icon in the system tray and select *Profile*.
- 2 Click the *WPS AOSS* button.



It will take several seconds for your wireless connection to be configured. When the 2.4 GHz and 5 GHz LEDs on the front of the AirStation stop flashing and glow steadily, the connection is complete.

OS X (AOSS Assistant)

If you are using OS X 10.9, 10.8, 10.7, 10.6, 10.5, or 10.4, use the AOSS Assistant to connect wirelessly with AOSS.

- 1 Run the AOSS Assistant program that was downloaded from the Buffalo website.
- 2 The software license screen is displayed. Click *Agree* to proceed.
- 3 Click *Start AOSS*.

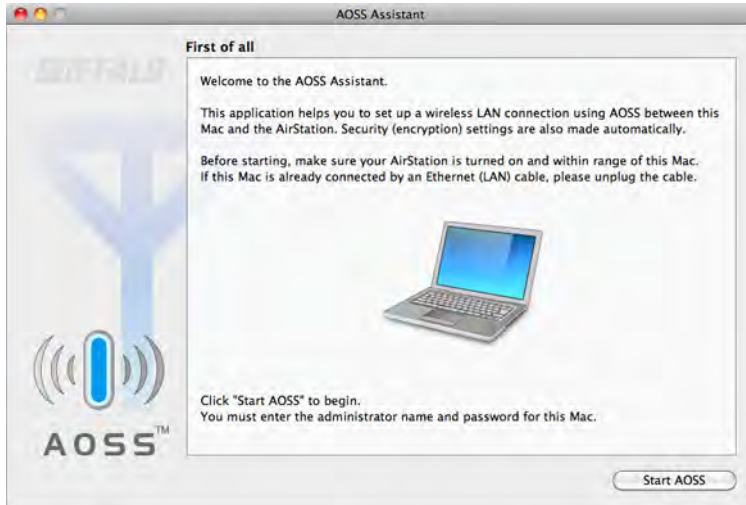

- 4 Enter the Mac's username and password and click *OK*.

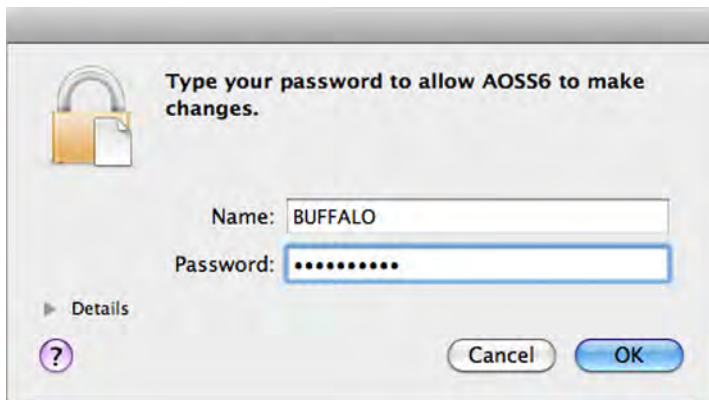

It will take several seconds for your wireless connection to be configured. When the 2.4 GHz and 5 GHz LEDs on the front of the AirStation stop flashing and glow steadily, the connection is complete.

Manual Setup

You can also connect to the AirStation without installing Client Manager V or Client Manager 3 by using the utility built into the operating system. The procedure varies depending on which operating system you are using.

Windows 8.1/Windows 8 (WLAN AutoConfig)

With Windows 8, use WLAN AutoConfig to connect to the AirStation.

- 1 Switch Windows 8 to desktop mode.
- 2 Click  network icon in the system tray.
- 3 Select the target AirStation's name and click *Connect*.
If you will be connecting to this device again, check *Connect automatically*.

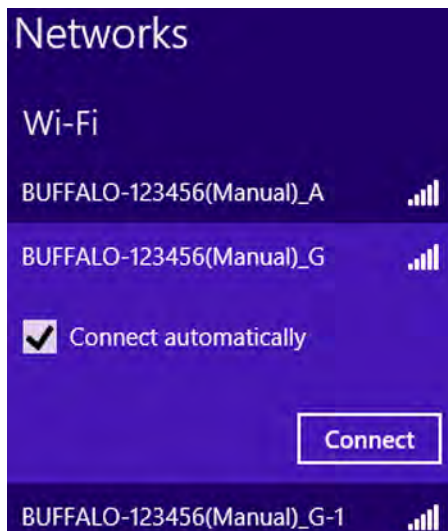

- 4 Enter the encryption key and click *Next*.

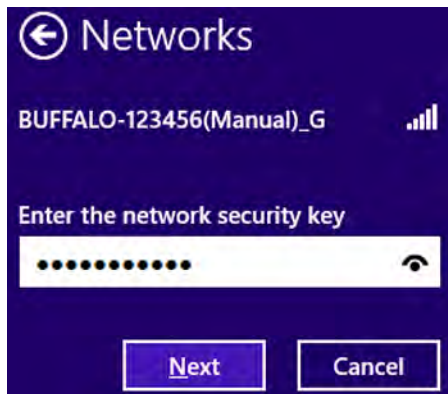

- 5 Click *No, don't turn on sharing or connect to devices*.



Windows 7 (WLAN AutoConfig)

With Windows 7, use WLAN AutoConfig to connect to the AirStation.

- 1 Click  network icon in the system tray.
- 2 Select the target AirStation and click *Connect*.
If you will connect to this device again, check *Connect automatically*.

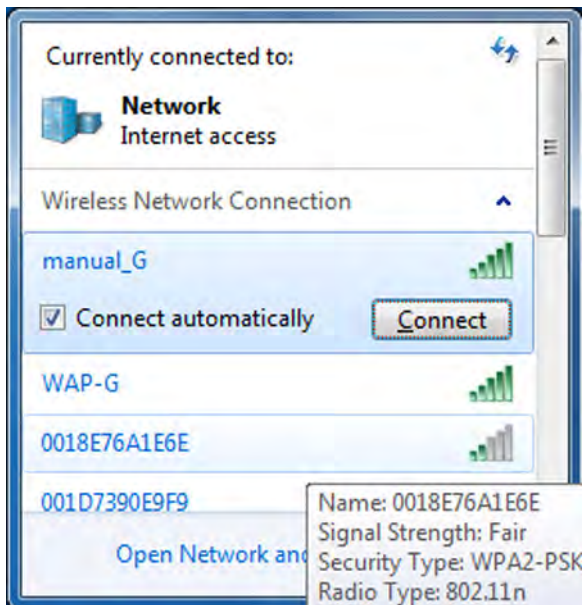

- 3 Enter the encryption key and click *OK*.



Windows Vista (WLAN AutoConfig)

With Windows Vista, use WLAN AutoConfig to connect to the AirStation.

- 1 Right-click the wireless network  icon in the system tray.
- 2 Click *Connect to a network*.
- 3 When this screen is displayed, select your network and click *Connect*.

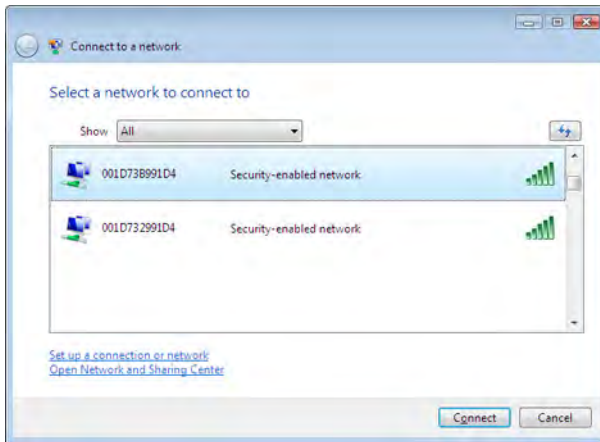

If the screen below is displayed, click *I want to enter the network key or passphrase instead*. Otherwise, go to step 4.

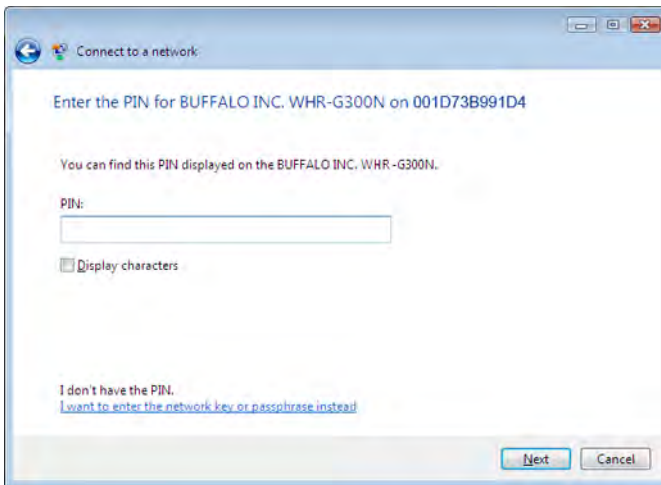
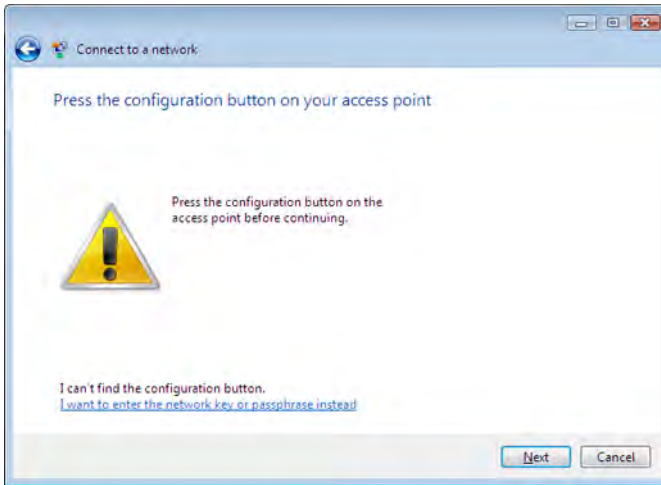

4 Enter the encryption key and click *Connect*.



Step through the wizard to finish configuration.

If the *Set Network Location* screen is displayed, select *Home*, *Work*, or *Public location* depending on where you're using the AirStation.

Windows XP (Wireless Zero Configuration)

Windows XP includes Wireless Zero Config, a built-in utility to connect to your AirStation.

Note: If Client Manager 3 is installed on your computer, Wireless Zero Config is disabled. Uninstall Client Manager 3 to use Wireless Zero Config, or just use Client Manager 3 to connect to the AirStation.

- 1 Right-click on the  wireless network icon in the system tray.
- 2 Click *View Available Wireless Networks*.
- 3 Select the network to connect to and click *Connect*.

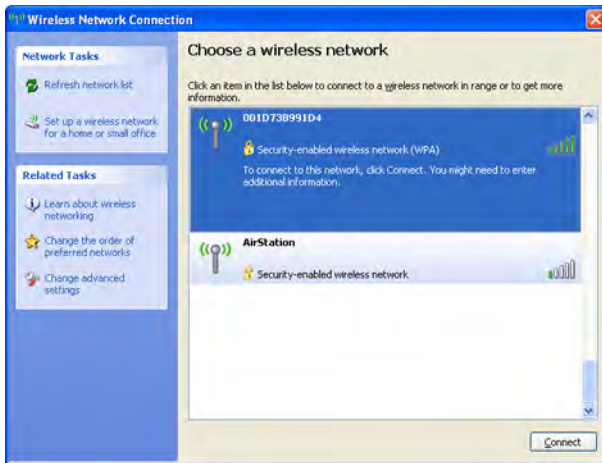

- 4 Enter the network key (also called a WEP or WPA key) twice and click *Connect*.



It will take several seconds for configuration to finish.

OS X (Wi-Fi)

Use Wi-Fi on a Mac to connect to the AirStation.

Note: In OS X 10.6 and earlier, "Wi-Fi" appears as "AirPort".

- 1 Click  icon in the top section of the screen and select *Turn Wi-Fi On*.

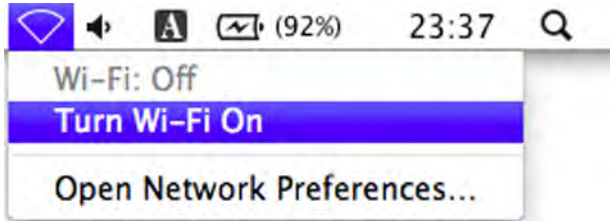

- 2 Find the AirStation's SSID on the list.
Click it to highlight it.

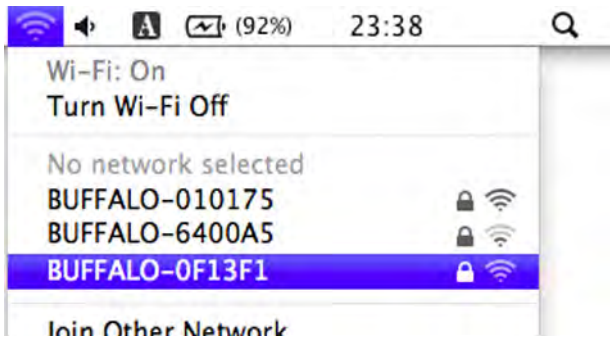

- 3 Enter the password, check *Remember this network*, and click *OK*.

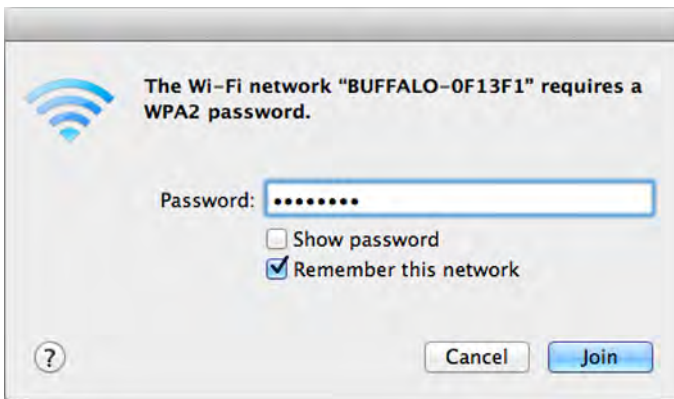

It will take several seconds for configuration to complete.

Chapter 5 - Checking Wireless Signal Quality

Windows 8.1, Windows 8, Windows 7, Windows Vista, and OS X (10.4 and later) users can use software supplied with the AirStation to check the quality and strength of the wireless signal.

Windows 8.1, Windows 8, Windows 7, and Windows Vista

Notes:

- If Client Manager V is not installed yet, download it from the Buffalo website and install it.
- Client Manager V does not support Windows XP.

1 Launch Client Manager V.

2 Click *Advanced Setup*.

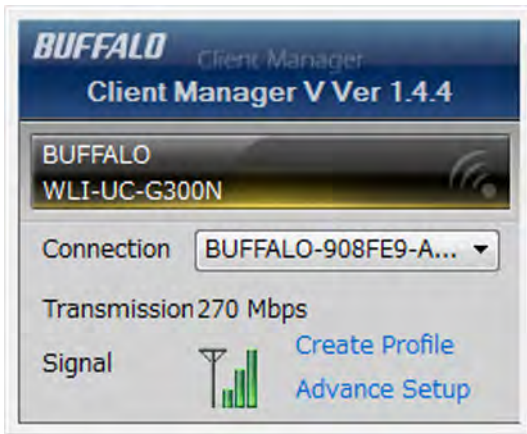

3 When the Client Manager V status screen is displayed, click  .

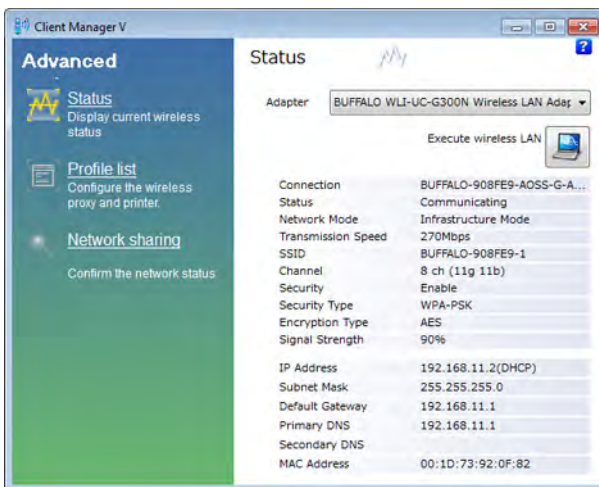



Connection Status	Signal strength (dBm), link speed (Mbps), and signal quality (%) are displayed in one-minute intervals on a real-time graph.
Usage Status by Channel	For 11b/11g, it shows usage in the 2.4 GHz band channels 1 to 14. For 11a, it shows usage in the W52, W53, and W56 channels.

Colors are used to indicate the signal strength of the access point. Colors closer to red indicate an access point with a stronger signal strength, and colors closer to blue indicate an access point with a weaker signal strength.

OS X

- 1 Run the WLAN Monitor program that was downloaded from the Buffalo website.
- 2 The software license screen displays the first time you start the software. Click *Agree* to proceed.

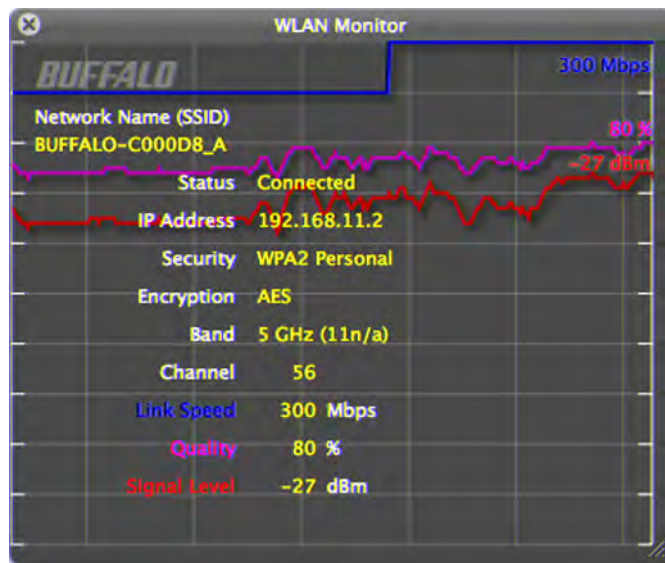

Network Name (SSID)	Displays SSID of the currently-connected AirStation.
Status	Displays current connection status.
IP Address	Displays IP address of the current Wi-Fi port.
Security	Displays the authentication method for the current connection target.
Encryption	Displays the encryption type for the current connection target.
Band	Displays the wireless band for the current connection target.
Channel	Displays the wireless channel for the current connection target.
Link Speed (Mbps)	Displays current link speed.
Quality (%)	Displays current signal quality.
Signal Level (dBm)	Displays current signal strength.

Chapter 6 - Default Configuration Settings

Feature	Parameter	Default Setting
LAN-side IP Address	IP Address Assignment	DHCP Client
	IP Address	Assigned by an external DHCP server
	Subnet Mask	Assigned by an external DHCP server
	Default Gateway	Assigned by an external DHCP server
	Primary Address Secondary Address	Assigned by an external DHCP server
LAN Port	Wired LAN Port (#1) Wired LAN Port (#2)	Enabled Speed & Duplex: Auto MDI: Auto Flow Control: Enabled 802.3az: Enabled
VLAN	Interface VLAN	Wired LAN Port (#1) / Wired LAN Port (#2) VLAN mode: Untagged VLAN ID: 1
	Management VLAN	VLAN ID: 1
Proxy ARP	Proxy ARP	Disabled
	Proxy ARP Aging Time	300
Bridge	Rapid STP	Off
	Aging Time	300
	BPDU Forwarding	Enabled
	Bridge Priority	32768
	Forward Delay	15
	Max Age	20
	Transmit Hold Count	6
	Auto Edge	Disabled
	Bridge Port Settings	Wired LAN Port Port Priority: 128 Path Cost: 20000 Edge Port: Disabled Point to Point: Auto-select Wireless Port Priority: 128 Path Cost: 200000 Edge Port: Disabled Point to Point: Auto-select

Feature	Parameter	Default Setting
AOSS	AOSS Button on the AirStation Unit	Enabled
	Allowed Bands	11a and 11g
	WEP Authentication	802.11g: AOSS is disabled. 802.11a: AOSS is disabled.
	TKIP Authentication	802.11g: AOSS is disabled. 802.11a: AOSS is disabled.
	VLAN Mode	802.11g (AES/TKIP): Untagged 802.11g (WEP): Untagged 802.11a (AES/TKIP): Untagged 802.11a (WEP): Untagged
	VLAN ID	802.11g (AES/TKIP): 1 802.11g (WEP): 1 802.11a (AES/TKIP): 1 802.11a (WEP): 1
WPS	WPS	Enabled
Basic	Radio	802.11g: Enabled 802.11a: Enabled
	Band	802.11g: 11b/g/n 802.11a: 11a/n
	Enable SSID#	802.11g: 1 802.11a: 1
	SSID 1	802.11g: BUFFALO-XXXXXX (where "XXXXXX" is the last 6 digits of the AirStation's MAC address) + "_G" 802.11a: BUFFALO-XXXXXX (where "XXXXXX" is the last 6 digits of the AirStation's MAC address) + "_A"
	VLAN Mode	802.11g: Untagged 802.11a: Untagged
	VLAN ID	802.11g: 1 802.11a: 1
	Auto Channel	802.11g: Enabled 802.11a: Enabled
	Auto Channel Range	802.11g: 1 - 11 ch 802.11a: W52
	Check Auto-channel	802.11g: Half hour 802.11a: Half hour
	Channel Bandwidth	802.11g: 20 MHz 802.11a: 40 MHz
	BSS Basic Rate Set	802.11g: 1, 2, 5.5, 11 Mbps 802.11a: 6, 12, 24 Mbps
	Multicast Rate	802.11g: Auto 802.11a: Auto

Feature	Parameter	Default Setting
Advanced	Contention Slot (802.11g only)	802.11g: Short
	Preamble Type (802.11g only)	802.11g: Long
	Guard Interval	802.11g: Short GI 802.11a: Short GI
	802.11g Protection (802.11g only)	802.11g: Enabled
	802.11n Protection	802.11g: Enabled 802.11a: Enabled
	DTIM Period	802.11g: 1 802.11a: 1
	RTS Threshold	802.11g: 2347 802.11a: 2347
	Fragment Threshold	802.11g: 2346 802.11a: 2346
	Tx Power	802.11g: 100 % 802.11a: 100 %
	Beacon Interval	802.11g: 100 802.11a: 100
	Station Keepalive	802.11g: 60 802.11a: 60
	SM Power Save	802.11g: Disabled 802.11a: Disabled
Security	SSID	802.11g: BUFFALO-XXXXXX (where "XXXXXX" is the last 6 digits of the AirStation's MAC address) + "_G" 802.11a: BUFFALO-XXXXXX (where "XXXXXX" is the last 6 digits of the AirStation's MAC address) + "_A"
	Broadcast SSID	802.11g: Enabled 802.11a: Enabled
	Wireless Client Isolation	802.11g: Disabled 802.11a: Disabled
	Load Balancing	802.11g: 25 / 25 802.11a: 25 / 25
	Authentication Method	802.11g: No authentication 802.11a: No authentication
	Additional Authentication	802.11g: No additional authentication 802.11a: No additional authentication
Clients	WLAN Client Table	802.11g: None 802.11a: None

Feature	Parameter	Default Setting		
WDS	WDS Functionality	802.11g: Disabled 802.11a: Disabled		
	Local MAC Address	802.11g: - 802.11a: -		
	Wireless MAC Address of WDS Peer	802.11g: - 802.11a: -		
	VLAN Mode	802.11g: Untagged port 802.11a: Untagged port		
	VLAN ID	802.11g: - 802.11a: -		
	Encryption	802.11g: None 802.11a: None		
RADIUS	Primary RADIUS Server (11g) Secondary RADIUS Server (11g) Primary RADIUS Server (11a) Secondary RADIUS Server (11a)	RADIUS Server: - Authentication Port: 1812 Shared Secret : - Session Timeout : 3600 seconds		
MAC Filter	MAC Address Filtering Table	None		
WMM	QoS	Disabled		
	WMM-EDCA Parameters (Priority AC_BK (Low))		For AP	For STA
		CWMin	4	4
		CWMax	10	10
		Aifsn	7	7
		Txop	0	0
	WMM-EDCA Parameters (Priority AC_BE (Normal))		For AP	For STA
		CWMin	4	4
		CWMax	6	10
		Aifsn	3	3
		Txop	0	0
	WMM-EDCA Parameters (Priority AC_VI (High))		For AP	For STA
		CWMin	3	3
		CWMax	4	4
		Aifsn	1	2
		Txop	94	94
WMM-EDCA Parameters (Priority AC_VO (Highest))		For AP	For STA	
	CWMin	2	2	
	CWMax	3	3	
	Aifsn	1	2	
	Txop	47	47	

Feature	Parameter	Default Setting
Username and Password	Administrator Name	admin
	Administrator Password	password
	Username	user
	Password	password
	AirStation Name	"AP" + AirStation's MAC Address
	Management Protocol	HTTP : Enabled HTTPS : Enabled SNMP : Disabled
	SNMP Version	v1 / v2c
	SNMP Get community	public
	SNMP Set community	private
	SNMP Trap	Disabled
	SNMP Trap community	public
	SNMP Trap Manager	None
Date and Time	Local Time	Year: 2013, Month: Sep, Day: 1 Hour: 0, Minutes: 00, Seconds: 00
	Use NTP	Disabled
	Server Name	None
	Update Interval	24 hours
	Time Zone	(GMT-6:00) Central America, or (GMT) Greenwich Mean Time: Dublin, Edinburgh, Lisbon, London
Transfer Logs to Syslog Server	Log Transfer	Disabled
	Syslog Server	None
	Copy Logs to Attached USB Device	Disabled
Admin Tools	Status	Unregistered
Save / Restore Settings	Restore Method	Restore from a file on your PC
Firmware Update	Update firmware from	a file on your PC
LED Settings	Power LED	On
	LAN LED	On
	Wireless LED	On
	USB LED	On
I'm Here	Duration of Sound	10 seconds

Appendix A - Specifications

Wireless LAN Interface	
Standard Compliance	IEEE802.11a / IEEE802.11b / IEEE802.11g / IEEE802.11n
Transmission Method	Direct Sequence Spread Spectrum (DSSS), OFDM, MIMO
Frequency Range	Available frequencies depend on the country of purchase. See the next page for details.
Transmission Rate	<p>802.11b: 11, 5.5, 2, 1 Mbps</p> <p>802.11a/g: 54, 48, 36, 24, 18, 12, 9, 6 Mbps</p> <p>802.11n: 20 MHz BW (Long GI) 130, 117, 104, 78, 52, 39, 26, 13 Mbps (2 stream) 65, 58.5, 52, 39, 26, 19.5, 13, 6.5 Mbps (1 stream) 20 MHz BW (Short GI) 144.4, 130, 115.6, 86.7, 57.8, 43.3, 28.9, 14.4 Mbps (2 stream) 72.2, 65, 57.8, 43.3, 28.9, 21.7, 14.4, 7.2 Mbps (1 stream) 40 MHz BW (Long GI) 270, 243, 216, 162, 108, 81, 54, 27 Mbps (2 stream) 135, 121.5, 108, 81, 54, 40.5, 27, 13.5 Mbps (1 stream) 40 MHz BW (Short GI) 300, 270, 240, 180, 120, 90, 60, 30 Mbps (2 stream) 150, 135, 120, 90, 60, 45, 30, 15 Mbps (1 stream)</p>
Access Mode	Infrastructure Mode, WDS Mode
Security	AOSS, WPA2 (TKIP/AES), WPA (TKIP/AES), WPA/WPA2 mixed PSK, IEEE 802.1X / EAP, 64-bit and 128-bit WEP, Mac Address Filter
Wired LAN Interface	
Standard Compliance	IEEE802.3ab (1000BASE-T), IEEE802.3u (100BASE-TX), IEEE802.3 (10BASE-T)
Transmission Rate	10 / 100 / 1000 Mbps
Transmission Encoding	1000BASE-T 4DPAM5, 100BASE-TX 4B5B/MLT-3, 10BASE-T Manchester Coding
Access Method	CSMA/CD
Speed and Flow Control	10 / 100 / 1000 Mbps, Auto Sensing, Auto MDIX
Number of LAN Ports	2
LAN Port Connector	RJ-45
USB Interface	
Interface	USB 2.0
Connector Type	Type A (plug)
Compliance	5.0 V 500 mA (max 1000 mA)

Other	
Power Supply	External AC 100-240 V Universal, 50/60 Hz Power over Ethernet
Power Consumption	About 7.2 W (Max)
Dimensions	152 mm x 182 mm x 35 mm (5.98 x 7.17 x 1.38 in.)
Weight	416 g (14.67 oz.) (not including antennas)
Operating Environment	0 - 45° C (32 - 104° F), 10 - 85% (non-condensing)

Frequency Range	
USA	2,412 - 2,462 MHz (Channels 1 - 11)
Canada	5,180 - 5,240 MHz (Channels 36, 40, 44, 48)
Brazil	5,745 - 5,825 MHz (Channels 149, 153, 157, 161, 165)
Mexico	2,412 - 2,472 MHz (Channels 1 - 13) 5,180 - 5,240 MHz (Channels 36, 40, 44, 48) 5,745 - 5,825 MHz (Channels 149, 153, 157, 161, 165)
EU Russia Kuwait Saudi Arabia UAE Australia Hong Kong The Philippines India Thailand Malaysia Singapore Vietnam	2,412 - 2,472 MHz (Channels 1 - 13) 5,180 - 5,240 MHz (Channels 36, 40, 44, 48)
South Korea	2,412 - 2,472 MHz (Channels 1 - 13) 5,745 - 5,825 MHz (Channels 149, 153, 157, 161, 165)
China Taiwan	2,412 - 2,462 MHz (Channels 1 - 11) 5,745 - 5,825 MHz (Channels 149, 153, 157, 161, 165)

Appendix B - TCP/IP Settings

Windows 8.1/Windows 8

To configure TCP/IP in Windows 8.1 or Windows 8, follow the procedure below.

- 1** Open *Control Panel*.
- 2** Click *Network and Internet*.
- 3** Click *Network and Sharing Center*.
- 4** Click *Change adapter settings* on the left side menu.
- 5** Right-click the network adapter, then click *Properties*.
- 6** If the User Account Control screen opens, click *Yes* or *Continue*.
- 7** Select *Internet Protocol Version 4 (TCP/IPv4)* then click *Properties*.
- 8** To have DHCP set your IP address settings automatically, check *Obtain an IP address automatically* and *Obtain DNS server address automatically*.

Alternately, you can configure the settings manually. For example:

If the router's IP address is 192.168.11.1,
IP address: 192.168.11.80
Subnet mask: 255.255.255.0
Default gateway: 192.168.11.1
Preferred DNS server: 192.168.11.1
Alternate DNS server: blank

- 9** Click *OK*.

Windows 7

To configure TCP/IP in Windows 7, follow the procedure below.

- 1** Open *Control Panel*.
- 2** Click *Network and Sharing Center*.
- 3** Click *Change Adapter Settings* on the left side menu.
- 4** Right-click on the network adapter, then click *Properties*.
- 5** If the User Account Control screen opens, click *Yes* or *Continue*.
- 6** Select *Internet Protocol Version 4 (TCP/IPv4)* then click *Properties*.
- 7** To have DHCP set your IP address settings automatically, check *Obtain an IP address automatically* and *Obtain DNS server address automatically*.

Alternately, you can configure the settings manually. For example:

If the router's IP address is 192.168.11.1,

IP address: 192.168.11.80

Subnet mask: 255.255.255.0

Default gateway: 192.168.11.1

Preferred DNS server: 192.168.11.1

Alternate DNS server: blank

- 8** Click *OK*.

Windows Vista

To configure TCP/IP in Windows Vista, follow the procedure below.

- 1** Open *Control Panel*.
- 2** Click *Network and Sharing Center*.
- 3** Click *Manage network connections* on the left side menu.
- 4** Right-click on the network adapter, then click *Properties*.
- 5** If the User Account Control screen opens, click *Yes* or *Continue*.
- 6** Select *Internet Protocol Version 4 (TCP/IPv4)*, then click *Properties*.
- 7** To have DHCP set your IP address settings automatically, check *Obtain an IP address automatically* and *Obtain DNS server address automatically*.

Alternately, you can configure the settings manually. For example:

If the router's IP address is 192.168.11.1,

IP address: 192.168.11.80

Subnet mask: 255.255.255.0

Default gateway: 192.168.11.1

Preferred DNS server: 192.168.11.1

Alternate DNS server: blank

- 8** Click *Close*.

Windows XP

To configure TCP/IP in Windows XP, follow the procedure below.

- 1** Open *Control Panel*.
- 2** Double-click *Network*.
- 3** Right-click on the network adapter, then click *Properties*.
- 4** Select *Internet Protocol (TCP/IP)*, then click *Properties*.
- 5** To have DHCP set your IP address settings automatically, check *Obtain an IP address automatically* and *Obtain DNS server address automatically*.

Alternately, you can configure the settings manually. For example:

If the router's IP address is 192.168.11.1,
IP address: 192.168.11.80
Subnet mask: 255.255.255.0
Default gateway: 192.168.11.1
Preferred DNS server: 192.168.11.1
Alternate DNS server: blank

- 6** Click *Close*.

OS X

To configure TCP/IP in OS X, follow the procedure below.

- 1** Click *Apple menu* > *System Preferences...*
- 2** Click *Network*.
- 3** Click the network adapter.
- 4** To have DHCP set your IP address settings automatically, select *Using DHCP* in the Configure IPv4 field.

To set your IP address settings manually, select *Manually* in the Configure IPv4 field and enter values for each setting. For example:

If the router's IP address is 192.168.11.1,
IP Address: 192.168.11.80
Subnet Mask: 255.255.255.0
Router: 192.168.11.1
DNS Server: 192.168.11.1
Search Domains: blank

- 5** Click *Apply*.

Appendix C - Restoring the Default Configuration

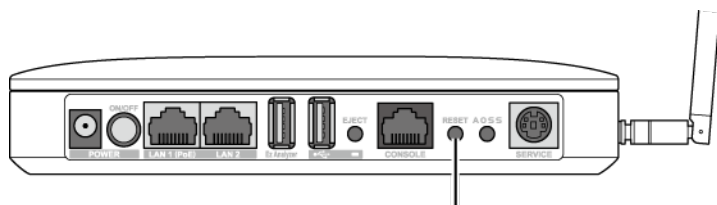

To return the AirStation to factory default settings while it is powered on, press and hold the reset button for 3 seconds.

Appendix D - Regulatory Compliance Information

Federal Communication Commission Interference Statement

The information below is only for US region.

This equipment has been tested and found to comply with the limits for a Class B digital device, pursuant to Part 15 of the FCC Rules. These limits are designed to provide reasonable protection against harmful interference in a residential installation. This equipment generates, uses and can radiate radio frequency energy and, if not installed and used in accordance with the instructions, may cause harmful interference to radio communications. However, there is no guarantee that interference will not occur in a particular installation. If this equipment does cause harmful interference to radio or television reception, which can be determined by turning the equipment off and on, the user is encouraged to try to correct the interference by one of the following measures:

- Reorient or relocate the receiving antenna.
- Increase the separation between the equipment and receiver.
- Connect the equipment into an outlet on a circuit different from that to which the receiver is connected.
- Consult the dealer or an experienced radio/TV technician for help.

FCC Caution:

Any changes or modifications not expressly approved by the party responsible for compliance could void the user's authority to operate this equipment.

This device complies with Part 15 of the FCC Rules. Operation is subject to the following two conditions: (1) This device may not cause harmful interference, and (2) this device must accept any interference received, including interference that may cause undesired operation.

Important Note - FCC Radiation Exposure Statement:

This equipment complies with FCC radiation exposure limits set forth for an uncontrolled environment. This equipment should be installed and operated with minimum distance 20cm between the radiator & your body.

This transmitter must not be co-located or operating in conjunction with any other antenna or transmitter. The device is only for indoor usage.

Industry Canada statement:

The information below is only for Canada region.

This device complies with Industry Canada's license-exempt RSSs. Operation is subject to the following two conditions: (1) this device may not cause interference, and (2) this device must accept any interference, including interference that may cause undesired operation of the device.

Le présent appareil est conforme aux CNR d'Industrie Canada applicables aux appareils radio exempts de licence. L'exploitation est autorisée aux deux conditions suivantes : (1) l'appareil ne doit pas produire de brouillage, et (2) l'utilisateur de l'appareil doit accepter tout brouillage radioélectrique subi, même si le brouillage est susceptible d'en

compromettre le fonctionnement.

Caution:

(i) The device for the band 5150-5250 MHz is only for indoor usage to reduce potential for harmful interference to co-channel mobile satellite systems.

(ii) The maximum antenna gain permitted for devices in the band 5725-5825 MHz shall comply with the e.i.r.p. limits specified for point-to-point and non point-to-point operation as appropriate.

High power radars are allocated as primary users (meaning they have priority) of 5250-5350 MHz and 5650-5850 MHz and these radars could cause interference and/or damage to LE-LAN devices.

This transmitter must not be co-located or operating in conjunction with any other antenna or transmitter.

(i) Le dispositif fonctionnant dans la bande 5150-5250 MHz est réservé uniquement pour une utilisation à l'intérieur afin de réduire les risques de brouillage préjudiciable aux systèmes de satellites mobiles utilisant les mêmes canaux.

(ii) Le gain maximal d'antenne permis (pour les dispositifs utilisant la bande 5725-5825 MHz) doit se conformer à la limite de p.i.r.e. spécifiée pour l'exploitation point à point et non point à point, selon le cas.

Les utilisateurs de radars de haute puissance sont désignés utilisateurs principaux (c.-à-d., qu'ils ont la priorité) pour les bandes 5250-5350 MHz et 5650-5850 MHz et que ces radars pourraient causer du brouillage et/ou des dommages aux dispositifs LAN-EL.

L'antenne utilisée pour ce transmetteur ne doit pas être co-localisés en conjonction avec toute autre antenne ou transmetteur.

Under Industry Canada regulations, this radio transmitter may only operate using an antenna of a type and maximum (or lesser) gain approved for the transmitter by Industry Canada. To reduce potential radio interference to other users, the antenna type and its gain should be so chosen that the equivalent isotropically radiated power (e.i.r.p.) is not more than that necessary for successful communication.

Conformément à la réglementation d'Industrie Canada, le présent émetteur radio peut fonctionner avec une antenne d'un type et d'un gain maximal (ou inférieur) approuvé pour l'émetteur par Industrie Canada. Dans le but de réduire les risques de brouillage radioélectrique à l'intention des autres utilisateurs, il faut choisir le type d'antenne et son gain de sorte que la puissance isotrope rayonnée équivalente (p.i.r.e.) ne dépasse pas l'intensité nécessaire à l'établissement d'une communication satisfaisante.

Antenna General Information			
No.	Ant. Cat.	Ant. Type	Gain (dBi)
1	External	Dipole	2.89
2	External	Dipole	2.89

Important Note - Canada Radiation Exposure Statement:

This equipment complies with Canada radiation exposure limits set forth for an uncontrolled environment. This equipment should be installed and operated with minimum distance 20 cm between the radiator and your body.

NOTE IMPORTANTE: (Pour l'utilisation de dispositifs mobiles)

Déclaration d'exposition aux radiations:

Cet équipement est conforme aux limites d'exposition aux rayonnements IC établies pour un environnement non contrôlé. Cet équipement doit être installé et utilisé avec un minimum de 20 cm de distance entre la source de rayonnement et votre corps.

Europe - EU Declaration of Conformity

This device complies with the essential requirements of the R&TTE Directive 1999/5/EC. The following test methods have been applied in order to prove presumption of conformity with the essential requirements of the R&TTE Directive 1999/5/EC:

EN 60950-1:2006+A11:2009+A1:2010+A12:2011

Safety of Information Technology Equipment

EN 50385 : (2002-08)

Product standard to demonstrate the compliance of radio base stations and fixed terminal stations for wireless telecommunication systems with the basic restrictions or the reference levels related to human exposure to radio frequency electromagnetic fields (110MHz - 40 GHz) - General public

EN 300 328 V1.7.1: (2006-10)

Electromagnetic compatibility and Radio spectrum Matters (ERM); Wideband Transmission systems; Data transmission equipment operating in the 2,4 GHz ISM band and using spread spectrum modulation techniques; Harmonized EN covering essential requirements under article 3.2 of the R&TTE Directive

EN 301 893 V1.6.1: (2011-11)

Broadband Radio Access Networks (BRAN); 5 GHz high performance RLAN; Harmonized EN covering the essential requirements of article 3.2 of the R&TTE Directive

EN 301 489-1 V1.9.2: (2011-09)

Electromagnetic compatibility and Radio Spectrum Matters (ERM); ElectroMagnetic Compatibility (EMC) standard for radio equipment and services; Part 1: Common technical requirements

EN 301 489-17 V2.1.1 (2009-05)

Electromagnetic compatibility and Radio spectrum Matters (ERM); ElectroMagnetic Compatibility (EMC) standard for radio equipment; Part 17: Specific conditions for Broadband Data Transmission Systems

This device is a 2.4 GHz wideband transmission system (transceiver), intended for use in all EU member states and EFTA countries, except in France and Italy where restrictive use applies.

In Italy the end-user should apply for a license at the national spectrum authorities in order to obtain authorization to use the device for setting up outdoor radio links and/or for supplying public access to telecommunications and/or network services.

This device may not be used for setting up outdoor radio links in France and in some areas the RF output power may be limited to 10 mW EIRP in the frequency range of 2454 . 2483.5 MHz. For detailed information the end-user should contact the national spectrum authority in France.

The minimum distance between the user and/or any bystander and the radiating structure of the transmitter is 20 cm.

CE0700 

Česky *Czech*

Buffalo Technology Inc. tímto prohlašuje, že tento AirStation WAPS-APG600H / WAPS-AG300H je ve shodě se základními požadavky a dalšími příslušnými ustanoveními směrnice 1999/5/ES.

Dansk *Danish*

Undertegnede Buffalo Technology Inc. erklærer herved, at følgende udstyr AirStation WAPSAPG600H / WAPS-AG300H overholder de væsentlige krav og øvrige relevante krav i direktiv 1999/5/EF.

Deutsch *German*

Hiermit erklärt Buffalo Technology Inc. dass sich das Gerät AirStation WAPS-APG600H / WAPSAG300H in Übereinstimmung mit den grundlegenden Anforderungen und den übrigen einschlägigen Bestimmungen der Richtlinie 1999/5/EG befindet.

Eesti *Estonian*

Käesolevaga kinnitab Buffalo Technology Inc. seadme AirStation WAPS-APG600H / WAPSAG300H vastavust direktiivi 1999/5/EÜ põhinõuetele ja nimetatud direktiivist tulenevatele teistele asjakohastele sätetele.

English

Hereby, Buffalo Technology Inc. declares that this AirStation WAPS-APG600H / WAPS-AG300H is in compliance with the essential requirements and other relevant provisions of Directive 1999/5/EC.

Español *Spanish*

Por medio de la presente Buffalo Technology Inc. declara que el AirStation WAPS-APG600H / WAPSAG300H cumple con los requisitos esenciales y cualesquiera otras disposiciones aplicables o exigibles de la Directiva 1999/5/CE.

Ελληνική *Greek*

ΜΕ ΤΗΝ ΠΑΡΟΥΣΑ Buffalo Technology Inc. ΔΗΛΩΝΕΙ ΟΤΙ AirStation WAPS-APG600H / WAPS-AG300H ΣΥΜΜΟΡΦΩΝΕΤΑΙ ΠΡΟΣ ΤΙΣ ΟΥΣΙΩΔΕΙΣ ΑΠΑΙΤΗΣΕΙΣ ΚΑΙ ΤΙΣ ΛΟΙΠΕΣ ΣΧΕΤΙΚΕΣ ΔΙΑΤΑΞΕΙΣ ΤΗΣ ΟΔΗΓΙΑΣ 1999/5/ΕΚ.

Français *French*

Par la présente Buffalo Technology Inc. déclare que l'appareil AirStation WAPS-APG600H / WAPSAG300H est conforme aux exigences essentielles et aux autres dispositions pertinentes de la directive 1999/5/CE.

Italiano *Italian*

Con la presente Buffalo Technology Inc. dichiara che questo AirStation WAPS-APG600H / WAPSAG300H è conforme ai requisiti essenziali ed alle altre disposizioni pertinenti stabilite dalla direttiva 1999/5/CE.

Latviski *Latvian*

Ar šo Buffalo Technology Inc. deklarē, ka AirStation WAPS-APG600H / WAPS-AG300H atbilst Direktīvas 1999/5/EK būtiskajām prasībām un citiem ar to saistītajiem noteikumiem.

Lietuvių *Lithuanian*

Šiuo Buffalo Technology Inc. deklaruoja, kad šis AirStation WAPS-APG600H / WAPS-AG300H atitinka esminius reikalavimus ir kitas 1999/5/EB Direktyvos nuostatas.

Nederlands *Dutch*

Hierbij verklaart Buffalo Technology Inc. dat het toestel AirStation WAPS-APG600H / WAPS-AG300H in overeenstemming is met de essentiële eisen en de andere relevante bepalingen van richtlijn 1999/5/EG.

Malti *Maltese*

Hawnhekk, Buffalo Technology Inc. , jiddikjara li dan AirStation WAPS-APG600H / WAPS-AG300H jikkonforma mal-
ħtiġijiet essenzjali u ma provvedimenti oħrajn relevanti li hemm fid-Dirrettiva 1999/5/EC.

Magyar *Hungarian*

Alulírott, Buffalo Technology Inc. nyilatkozom, hogy a AirStation WAPS-APG600H / WAPS-AG300H megfelel a vonatkozó alapvető követelményeknek és az 1999/5/EC irányelv egyéb előírásainak.

Polski *Polish*

Niniejszym Buffalo Technology Inc. oświadcza, że AirStation WAPS-APG600H / WAPS-AG300H jest zgodny z zasadniczymi wymogami oraz pozostałymi stosownymi postanowieniami Dyrektywy 1999/5/EC.

Português *Portuguese*

Buffalo Technology Inc. declara que este AirStation WAPS-APG600H / WAPS-AG300H está conforme com os requisitos essenciais e outras disposições da Directiva 1999/5/CE.

Slovensko *Slovenian*

Buffalo Technology Inc. izjavlja, da je ta AirStation WAPS-APG600H / WAPS-AG300H v skladu z bistvenimi zahtevami in ostalimi relevantnimi določili direktive 1999/5/ES.

Slovensky *Slovak*

Buffalo Technology Inc. týmto vyhlasuje, že AirStation WAPS-APG600H / WAPS-AG300H spĺňa základné požiadavky a všetky príslušné ustanovenia Smernice 1999/5/ES.

Suomi *Finnish*

Buffalo Technology Inc. vakuuttaa täten että AirStation WAPS-APG600H / WAPS-AG300H tyyppinen laite on direktiivin 1999/5/EY oleellisten vaatimusten ja sitä koskevien direktiivin muiden ehtojen mukainen.

Svensk *Swedish*

Härmed intygar Buffalo Technology Inc. att denna AirStation WAPS-APG600H / WAPS-AG300H står i överensstämmelse med de väsentliga egenskapskrav och övriga relevanta bestämmelser som framgår av direktiv 1999/5/EG.

Taiwan:

SAR compliance has been established in typical laptop computer(s) with CardBus slot, and product could be used in typical laptop computer with CardBus slot. Other application like handheld PC or similar device has not been verified, may not comply with related RF exposure rules, and such use shall be prohibited.

Safety

This equipment is designed with the utmost care for the safety of those who install and use it. However, special attention must be paid to the dangers of electric shock and static electricity when working with electrical equipment. All guidelines of this manual and of the computer manufacturer must therefore be allowed at all times to ensure the safe use of the equipment.

根據NCC 低功率電波輻射性電機管制辦法：

第十二條：

經型式認證合格之低功率射頻電機，非經許可，公司、商號或使用者均不得擅自變更頻率、加大功率或變更原設計之特性及功能。

第十四條：

低功率射頻電機之使用不得影響飛航安全及干擾合法通信；經發現有干擾現象時，應立即停用，並改善至無干擾時方得繼續使用。前項合法通信，指依電信法規定作業之無線電通信。低功率射頻電機須忍受合法通信或工業、科學及醫療用電波輻射性電機設備之干擾。5.25-5.35兆赫頻帶內操作之無線資訊傳輸設備，限於室內使用。

기종별	사 용 자 안 내 문
B 급 기기(가정용 정보통신기기)	이 기기는 가정용 (B 급) 전자파적합기기로서 주로 가정에서 사용하는 것을 목적으로 하며 , 모든지역에서 사용할 수 있습니다 .

Appendix E - Environmental Information

- The equipment that you have purchased has required the extraction and use of natural resources for its production.
- The equipment may contain hazardous substances that could impact health and the environment.
- In order to avoid the dissemination of those substances in our environment and to diminish the pressure on the natural resources, we encourage you to use the appropriate take-back systems.
- The take-back systems will reuse or recycle most of the materials of your end life equipment in a sound way.
- The crossed-out wheeled bin symbol invites you to use those systems.



- If you need more information on collection, reuse, and recycling systems, please contact your local or regional waste administration.